Actel HDL Coding

Style Guide



Actel Corporation, Sunnyvale, CA 94086

© 1997 Actel Corporation. All rights reserved.

Printed in the United States of America

Part Number: 5029105-1

Release: May 1999

No part of this document may be copied or reproduced in any form or by any means without prior written consent of Actel.

Actel makes no warranties with respect to this documentation and disclaims any implied warranties of merchantability or fitness for a particular purpose.

Information in this document is subject to change without notice. Actel assumes no responsibility for any errors that may appear in this document.

This document contains confidential proprietary information that is not to be disclosed to any unauthorized person without prior written consent of Actel Corporation.

Trademarks

Actel and the Actel logotype are registered trademarks of Actel Corporation.

Verilog is a registered trademark of Open Verilog International.

All other products or brand names mentioned are trademarks or registered trademarks of their respective holders.

Table of Contents

Introduction	ix
Document Organization	ix
Document Assumptions	.x
Document Conventions	.x
HDL Keywords and Naming Conventions	xi
VHDL	xi
Verilog	xii
Actel Manuals	xiii
Related Manuals	xv
On-Line Help	xvi
1 Design Flow	1
Design Flow Illustrated	1
Design Flow Overview	2
Design Creation/Verification	2
Design Implementation	3
Programming	4
System Verification	4
2 Technology Independent Coding Styles	5
Sequential Devices	5
Flip-Flops (Registers)	5
D-Latches	13
Operators	17
Datapath	19
Priority Encoders Using If-Then-Else	19
Multiplexors Using Case	21
Decoders	26
Counters	27
Arithmetic Operators	31
Relational Operators	33
Equality Operator	34

Shift Operators	35
Finite State Machine	36
Mealy Machine	39
Moore Machine	43
Input-Output Buffers	46
Tri-State Buffer	47
Bi-Directional Buffer	49
Generics and Parameters.	51
3 Performance Driven Coding	53
Reducing Logic Levels on Critical Paths	53
Resource Sharing	55
Operators Inside Loops	57
Coding for Combinability	58
Register Duplication	59
Partitioning a Design	62
4 Technology Specific Coding Techniques	63
Multiplexors.	63
Internal Tri-State to Multiplexor Mapping	64
Registers	66
Synchronous Clear or Preset	67
Clock Enabled	68
Asynchronous Preset	70
Asynchronous Preset and Clear	73
Registered I/Os	73
CLKINT/CLKBUF for Reset and/or High Fanout Networks	75
QCLKINT/QCLKBUF for Medium Fanout Networks	77
ACTgen Counter.	77
Dual Architecture Coding in VHDL	79
SRAM.	82
Register-Based Single Port SRAM	82

Register-Based Dual-Port SRAM	84
ACTgen RAM	86
FIFO	88
Register-Based FIFO	88
ACTgen FIFO	94
A Product Support	97
Actel U.S. Toll-Free Line	97
Customer Service	97
Customer Applications Center	98
Guru Automated Technical Support	98
Web Site	98
FTP Site.	99
Electronic Mail	99
Worldwide Sales Offices	100
INDEX.	101

List of Figures

Actel HDL Synthesis-Based Design Flow	1
D Flip Flop	6
D Flip-Flop with Asynchronous Reset	7
D Flip-Flop with Asynchronous Preset	8
D Flip-Flop with Asynchronous Reset and Preset	9
D Flip-Flop with Synchronous Reset	10
D Flip-Flop with Synchronous Preset	11
D Flip-Flop with Asynchronous Reset and Clock Enable	12
D-Latch	13
D-Latch with Gated Asynchronous Data	14
D-Latch with Gated Enable	15
D-Latch with Asynchronous Reset	16
Priority Encoder Using an If-Then-Else Statement	19
Multiplexor Using a Case Statement	21
Basic Structure of a Moore FSM	37
Basic Structure of a Mealy FSM	38
Mealy State Diagram	39
Tri-State Buffer	47
Bi-Directional Buffer	49
Single Module Implementation of a Synchronous Clear or Preset Register	67
Single Module Implementation of a Clock Enabled Register	68
Asynchronous Preset	71
Equivalent Asynchronous Preset	71
Registered I/O Cell	73
RAM Behavioral Simulation Model	82
FIFO Behavioral Simulation Mode	88

Introduction

VHDL and Verilog® HDL are high level description languages for system and circuit design. These languages support various abstraction levels of design, including architecture-specific design. At the higher levels, these languages can be used for system design without regard to a specific technology. To create a functional design, you only need to consider a specific target technology. However, to achieve optimal performance and area from your target device, you must become familiar with the architecture of the device and then code your design for that architecture.

Efficient, standard HDL code is essential for creating good designs. The structure of the design is a direct result of the structure of the HDL code. Additionally, standard HDL code allows designs to be reused in other designs or by other HDL designers.

This document provides the preferred coding styles for the Actel architecture. The information is to be used as reference material with instructions to optimize your HDL code for the Actel architecture. Examples in both VHDL and Verilog code are provided to illustrate these coding styles and to help implement the code into your design.

For further information about HDL coding styles, synthesis methodology, or application notes, please visit Actel's website at the following URL: <http://www.actel.com/hdl>.

Document Organization

The *Actel HDL Coding Style Guide* is divided into the following chapters:

Chapter 1 - Design Flow describes the basic design flow for creating Actel designs with HDL synthesis and simulation tools.

Chapter 2 - Technology Independent Coding Styles describes basic high level HDL coding styles and techniques.

Chapter 3 - Performance Driven Coding illustrates efficient design practices and describes synthesis implementations and techniques that can be used to reduce logic levels on a critical path.

Chapter 4 - Technology Specific Coding Techniques describes how to implement technology specific features and technology specific macros for optimal area and performance utilization.

Appendix A - Product Support provides information about contacting Actel for customer and technical support.

Document Assumptions

The information in this manual is based on the following assumptions:

- You are familiar with Verilog or VHDL hardware description language, and HDL design methodology for designing logic circuits.
- You are familiar with FPGA design software, including design synthesis and simulation tools.

Document Conventions

The following conventions are used throughout this manual.

Information that is meant to be input by the user is formatted as follows:

keyboard input

The contents of a file is formatted as follows:

file contents

HDL code appear as follows, with HDL keyword in bold:

```
entity actel is  
port (  
    a: in bit;  
    y: out bit);  
end actel;
```

Messages that are displayed on the screen appear as follows:

Screen Message

HDL Keywords and Naming Conventions

There are naming conventions you must follow when writing Verilog or VHDL code. Additionally, Verilog and VHDL have reserved words that cannot be used for signal or entity names. This section lists the naming conventions and reserved keywords for each.

VHDL

The following naming conventions apply to VHDL designs:

- VHDL is not case sensitive.
- Two dashes "--" are used to begin comment lines.
- Names can use alphanumeric characters and the underscore "_" character.
- Names must begin with an alphabetic letter.
- You may not use two underscores in a row, or use an underscore as the last character in the name.
- Spaces are not allowed within names.
- Object names must be unique. For example, you cannot have a signal named A and a bus named A(7 **downto** 0).

The following is a list of the VHDL reserved keywords:

abs	downto	library	postponed	subtype
access	else	linkage	procedure	then
after	elsif	literal	process	to
alias	end	loop	pure	transport
all	entity	map	range	type
and	exit	mod	record	unaffected
architecture	file	nand	register	units
array	for	new	reject	until
assert	function	next	rem	use
attribute	generate	nor	report	variable
begin	generic	not	return	wait
block	group	null	rol	when

body	guarded	of	ror	while
buffer	if	on	select	with
bus	impure	open	severity	xnor
case	in	or	shared	xor
component	inertial	others	signal	
configuration	inout	out	sla	
constant	is	package	sra	
disconnect	label	port	srl	

Verilog

The following naming conventions apply to Verilog HDL designs:

- Verilog is case sensitive.
- Two slashes “//” are used to begin single line comments. A slash and asterisk “/*” are used to begin a multiple line comment and an asterisk and slash “*/” are used to end a multiple line comment.
- Names can use alphanumeric characters, the underscore “_” character, and the dollar “\$” character.
- Names must begin with an alphabetic letter or the underscore.
- Spaces are not allowed within names.

The following is a list of the Verilog reserved keywords:

always	endmodule	medium	reg	tranif0
and	endprimitive	module	release	tranif1
assign	endspecify	nand	repeat	tri
attribute	endtable	negedge	rnmos	tri0
begin	endtask	nmos	rpmos	tri1
buf	event	nor	rtran	triand
bufif0	for	not	rtranif0	trior
bufif1	force	notif0	rtranif1	trireg
case	forever	notif1	scalared	unsigned
casex	fork	or	signed	vectored
casez	function	output	small	wait
cmos	highz0	parameter	specify	wand

deassign	highz1	pmos	specparam	weak0
default	if	posedge	strength	weak1
defparam	ifnone	primitive	strong0	while
disable	initial	pull0	strong1	wire
edge	inout	pull1	supply0	wor
else	input	pulldown	supply1	xnor
end	integer	pullup	table	xor
endattribute	join	remos	task	
endcase	large	real	time	
endfunction	macromodule	realtime	tran	

Actel Manuals

The Designer Series software includes printed and on-line manuals. The on-line manuals are in PDF format on the CD-ROM in the “/manuals” directory. These manuals are also installed onto your system when you install the Designer software. To view the on-line manuals, you must install Adobe® Acrobat Reader® from the CD-ROM.

The Designer Series includes the following manuals, which provide additional information on designing Actel FPGAs:

Designing with Actel. This manual describes the design flow and user interface for the Actel Designer Series software, including information about using the ACTgen Macro Builder and ACTmap VHDL Synthesis software.

Actel HDL Coding Style Guide. This guide provides preferred coding styles for the Actel architecture and information about optimizing your HDL code for Actel devices.

ACTmap VHDL Synthesis Methodology Guide. This guide contains information, optimization techniques, and procedures to assist designers in the design of Actel devices using ACTmap VHDL.

Silicon Expert User's Guide. This guide contains information and procedures to assist designers in the use of Actel's Silicon Expert tool.

DeskTOP Interface Guide. This guide contains information about using the integrated VeriBest® and Synplicity® CAE software tools with the

Actel Designer Series FPGA development tools to create designs for Actel Devices.

Cadence® Interface Guide. This guide contains information and procedures to assist designers in the design of Actel devices using Cadence CAE software and the Designer Series software.

Mentor Graphics® Interface Guide. This guide contains information and procedures to assist designers in the design of Actel devices using Mentor Graphics CAE software and the Designer Series software.

MOTIVE™ Static Timing Analysis Interface Guide. This guide contains information and procedures to assist designers in the use of the MOTIVE software to perform static timing analysis on Actel designs.

Synopsys® Synthesis Methodology Guide. This guide contains preferred HDL coding styles and information and procedures to assist designers in the design of Actel devices using Synopsys CAE software and the Designer Series software.

Viewlogic Powerview® Interface Guide. This guide contains information and procedures to assist designers in the design of Actel devices using Powerview CAE software and the Designer Series software.

Viewlogic Workview Office Interface Guide. This guide contains information and procedures to assist designers in the design of Actel devices using Workview Office CAE software and the Designer Series software.

VHDL Vital Simulation Guide. This guide contains information and procedures to assist designers in simulating Actel designs using a Vital compliant VHDL simulator.

Verilog Simulation Guide. This guide contains information and procedures to assist designers in simulating Actel designs using a Verilog simulator.

Activator and APS Programming System Installation and User's Guide. This guide contains information about how to program and debug Actel devices, including information about using the Silicon Explorer diagnostic tool for system verification.

Silicon Sculptor User's Guide. This guide contains information about how to program Actel devices using the Silicon Sculptor software and device programmer.

Silicon Explorer Quick Start. This guide contains information about connecting the Silicon Explorer diagnostic tool and using it to perform system verification.

Designer Series Development System Conversion Guide UNIX® Environments. This guide describes how to convert designs created in Designer Series versions 3.0 and 3.1 for UNIX to be compatible with later versions of Designer Series.

Designer Series Development System Conversion Guide Windows Environments. This guide describes how to convert designs created in Designer Series versions 3.0 and 3.1 for Windows to be compatible with later versions of Designer Series.

Actel FPGA Data Book. This guide contains detailed specifications on Actel device families. Information such as propagation delays, device package pinout, derating factors, and power calculations are found in this guide.

Macro Library Guide. This guide provides descriptions of Actel library elements for Actel device families. Symbols, truth tables, and module count are included for all macros.

A Guide to ACTgen Macros. This Guide provides descriptions of macros that can be generated using the Actel ACTgen Macro Builder software.

Related Manuals

The following manuals provide additional information about designing and programming Actel FPGAs using HDL design methodology:

Digital Design and Synthesis with Verilog HDL. Madhavan, Rajeev, and others. San Jose, CA: Automata Publishing Company, 1993. This book contains information to allow designers to write synthesizable designs with Verilog HDL.

HDL Chip Design. Smith, Douglas J. Madison, AL: Doone Publications, 1996. This book describes and gives examples of how to design FPGAs using VHDL and Verilog.

IEEE Standard VHDL Language Reference Manual. New York: Institute of Electrical and Electronics Engineers, Inc., 1994. This manual specifies IEEE Standard 1076-1993, which defines the VHDL standard and the use of VHDL in the creation of electronic systems.

On-Line Help

The Designer Series software comes with on-line help. On-line help specific to each software tool is available in Designer, ACTgen, ACTmap, Silicon Expert, Silicon Explorer, Silicon Sculptor, and APSW.

Design Flow

This chapter illustrates and describes the basic design flow for creating Actel designs using HDL synthesis and simulation tools.

Design Flow Illustrated

Figure 1-1 illustrates the HDL synthesis-based design flow for an Actel FPGA using third party CAE tools and Designer software¹.

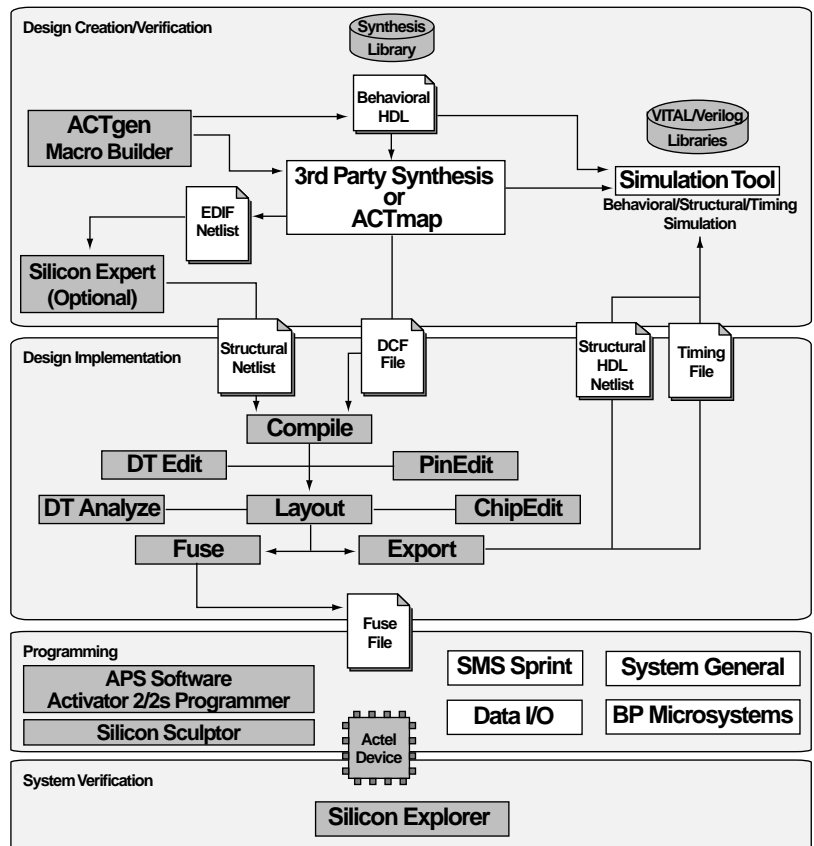

Figure 1-1. Actel HDL Synthesis-Based Design Flow

¹ Actel-specific utilities/tools are denoted by grey boxes in Figure 1-1.

Design Flow Overview

The Actel HDL synthesis-based design flow has four main steps; Design Creation/Verification, Design Implementation, Programming, and System Verification. These steps are described in detail in the following sections.

Design Creation/ Verification

During design creation/verification, a design is captured in an RTL-level (behavioral) HDL source file. After capturing the design, a behavioral simulation of the HDL file can be performed to verify that the HDL code is correct. The code is then synthesized into an Actel gate-level (structural) HDL netlist. After synthesis, a structural simulation of the design can be performed. Finally, an EDIF netlist is generated for use in Designer and an HDL structural netlist is generated for timing simulation.

HDL Design Source Entry

Enter your HDL design source using a text editor or a context-sensitive HDL editor. Your HDL source file can contain RTL-level constructs, as well as instantiations of structural elements, such as ACTgen macros.

Behavioral Simulation

You can perform a behavioral simulation of your design before synthesis. Behavioral simulation verifies the functionality of your HDL code. Typically, unit delays are used and a standard HDL test bench can be used to drive simulation. Refer to the documentation included with your simulation tool for information about performing behavioral simulation.

Synthesis

After you have created your behavioral HDL source file, you must synthesize it before placing and routing it in Designer. Synthesis translates the behavioral HDL file into a gate-level netlist and optimizes the design for a target technology. Refer to the documentation included with your synthesis tool for information about performing design synthesis.

EDIF Netlist Generation

After you have created, synthesized, and verified your design, you must generate an Actel EDIF netlist for place and route in Designer. This EDIF netlist is also used to generate a structural HDL netlist for use in structural simulation. Refer to the Designer Series documentation for information about generating an EDIF netlist.

Structural Netlist Generation

You can generate a structural HDL netlist from your EDIF netlist for use in structural simulation by either exporting it from Designer or by using the Actel “edn2vhdl” or “edn2vlog” program. Refer to the Designer Series documentation for information about generating a structural netlist.

Structural Simulation

You can perform a structural simulation of your design before placing and routing it. Structural simulation verifies the functionality of your post-synthesis structural HDL netlist. Default unit delays included in the compiled Actel VITAL libraries are used for every gate. Refer to the documentation included with your simulation tool for information about performing structural simulation.

Design Implementation

During design implementation, a design is placed and routed using Designer. Additionally, timing analysis is performed on a design in Designer with the DT Analyze tool. After place and route, post-layout (timing) simulation is performed.

Place and Route

Use Designer to place and route your design. Refer to the Designer Series documentation for information about using Designer.

Timing Analysis

Use the DT Analyze tool in Designer to perform static timing analysis on your design. Refer to the Designer Series documentation for information about using DT Analyze.

Timing Simulation

After placing and routing your design, you perform a timing simulation to verify that the design meets timing constraints. Timing simulation requires timing information exported from Designer, which overrides default unit delays in the compiled Actel VITAL libraries. Refer to the Designer Series documentation for information about exporting timing information from Designer.

Programming

Programming a device requires software and hardware from Actel or a supported 3rd party programming system. Refer to the *Designing with Actel* manual and the *Activator Installation and APS Programming Guide* for information on programming an Actel device.

System Verification

You can perform system verification on a programmed device using the Actel's Silicon Explorer. Refer to the *Activator Installation and APS Programming Guide* or *Silicon Explorer Quick Start* for information on using Silicon Explorer.

Technology Independent Coding Styles

This chapter describes basic, HDL coding styles and techniques. These coding styles are essential when writing efficient, standard HDL code and creating technology independent designs.

Sequential Devices

A sequential device, either a flip-flop or a latch, is a one-bit memory device. A latch is a level-sensitive memory device and a flip-flop is an edge-triggered memory device.

Flip-Flops (Registers)

Flip-flops, also called registers, are inferred in VHDL using wait and if statements within a process using either a rising edge or falling edge detection expression. There are two types of expressions that can be used, a 'event attribute or a function call. For example:

```
(clk'event and clk='1')      --rising edge 'event attribute
(clk'event and clk='0')      --falling edge 'event attribute
rising_edge(clock)           --rising edge function call
falling_edge(clock)          --falling edge function call
```

The examples in this guide use rising edge 'event attribute expressions, but falling edge expressions could be used. The 'event attribute expression is used because some VHDL synthesis tools may not recognize function call expressions. However, using a function call expression is preferred for simulation because a function call only detects an edge transition (0 to 1 or 1 to 0) but not a transition from X to 1 or 0 to X, which may not be a valid transition. This is especially true if using a multi-valued data type like `std_logic`, which has nine possible values (U, X, 0, 1, Z, W, L, H, -).

This section describes and gives examples for different types of flip-flops. Refer to “Registers” on page 66 for additional information about using specific registers in the Actel architecture.

Rising Edge Flip-Flop

The following examples infer a D flip-flop without asynchronous or synchronous reset or preset. This flip-flop is a basic sequential cell in the Actel antifuse architecture.

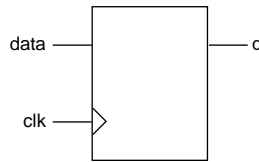

Figure 2-1. D Flip Flop

VHDL

```
library IEEE;
use IEEE.std_logic_1164.all;

entity dff is
port (data, clk : in std_logic;
      q : out std_logic);
end dff;

architecture behav of dff is
begin
process (clk) begin
    if (clk'event and clk = '1') then
        q <= data;
    end if;
end process;
end behav;
```

Verilog

```
module dff (data, clk, q);
    input data, clk;
    output q;
    reg q;
    always @(posedge clk)
        q = data;
endmodule
```

Rising Edge Flip-Flop with Asynchronous Reset

The following examples infer a D flip-flop with an asynchronous reset. This flip-flop is a basic sequential cell in the Actel antifuse architecture.

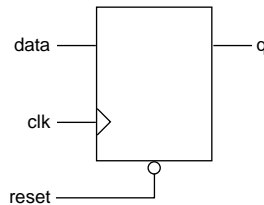

Figure 2-2. D Flip-Flop with Asynchronous Reset

VHDL

```

library IEEE;
use IEEE.std_logic_1164.all;

entity dff_async_rst is
port (data, clk, reset : in std_logic;
      q : out std_logic);
end dff_async_rst;

architecture behav of dff_async_rst is
begin
process (clk, reset) begin
  if (reset = '0') then
    q <= '0';
  elsif (clk'event and clk = '1') then
    q <= data;
  end if;
end process;
end behav;

```

Verilog

```

module dff_async_rst (data, clk, reset, q);
  input data, clk, reset;
  output q;
  reg q;
  always @(posedge clk or negedge reset)
    if (~reset)
      q = 1'b0;
    else
      q = data;
endmodule

```

Rising Edge Flip-Flop with Asynchronous Preset

The following examples infer a D flip-flop with an asynchronous preset. Refer to “Registers” on page 66 for additional information about using preset flip-flops with the Actel architecture.

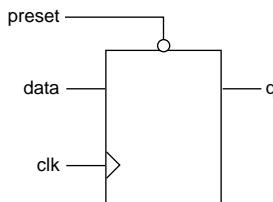

Figure 2-3. D Flip-Flop with Asynchronous Preset

VHDL

```
library IEEE;
use IEEE.std_logic_1164.all;

entity dff_async_pre is
port (data, clk, preset : in std_logic;
      q : out std_logic);
end dff_async_pre;

architecture behav of dff_async_pre is
begin
process (clk, preset) begin
  if (preset = '0') then
    q <= '1';
  elsif (clk'event and clk = '1') then
    q <= data;
  end if;
end process;
end behav;
```

Verilog

```
module dff_async_pre (data, clk, preset, q);
input data, clk, preset;
output q;
reg q;
always @(posedge clk or negedge preset)
  if (~preset)
    q = 1'b1;
  else
    q = data;
endmodule
```

Rising Edge Filp-Flop with Asynchronous Reset and Preset

The following examples infer a D flip-flop with an asynchronous reset and preset. Refer to “Registers” on page 66 for additional information about using preset flip-flops with the Actel architecture.

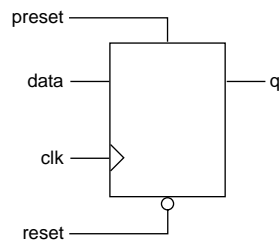

Figure 2-4. D Flip-Flop with Asynchronous Reset and Preset

VHDL

```

library IEEE;
use IEEE.std_logic_1164.all;

entity dff_async is
port (data, clk, reset, preset : in std_logic;
      q : out std_logic);
end dff_async;

architecture behav of dff_async is
begin
process (clk, reset, preset) begin
  if (reset = '0') then
    q <= '0';
  elsif (preset = '1') then
    q <= '1';
  elsif (clk'event and clk = '1') then
    q <= data;
  end if;
end process;
end behav;

```

Verilog

```

module dff_async (reset, preset, data, q, clk);
  input clk;
  input reset, preset, data;

```

```
output q;  
reg q;  
always @ (posedge clk or negedge reset or posedge preset)  
if (~reset)  
q = 1'b0;  
else if (preset)  
q = 1'b1;  
else q = data;  
endmodule
```

Rising Edge Flip-Flop with Synchronous Reset

The following examples infer a D flip-flop with a synchronous reset.

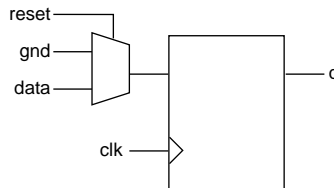

Figure 2-5. D Flip-Flop with Synchronous Reset

VHDL

```
library IEEE;  
use IEEE.std_logic_1164.all;  
  
entity dff_sync_rst is  
port (data, clk, reset : in std_logic;  
q : out std_logic);  
end dff_sync_rst;  
  
architecture behav of dff_sync_rst is  
begin  
process (clk) begin  
if (clk'event and clk = '1') then  
if (reset = '0') then  
q <= '0';  
else q <= data;  
end if;  
end if;  
end process;  
end behav;
```

Verilog

```

module dff_sync_rst (data, clk, reset, q);
    input data, clk, reset;
    output q;
    reg q;
    always @ (posedge clk)
        if (~reset)
            q = 1'b0;
        else q = data;
endmodule

```

Rising Edge Flip-Flop with Synchronous Preset

The following examples infer a D flip-flop with a synchronous preset.

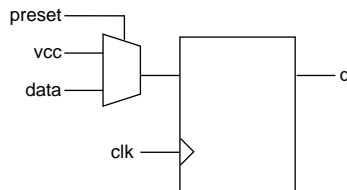

Figure 2-6. D Flip-Flop with Synchronous Preset

VHDL

```

library IEEE;
use IEEE.std_logic_1164.all;

entity dff_sync_pre is
    port (data, clk, preset : in std_logic;
          q : out std_logic);
end dff_sync_pre;

architecture behav of dff_sync_pre is
begin
    process (clk) begin
        if (clk'event and clk = '1') then
            if (preset = '0') then
                q <= '1';
            else q <= data;
            end if;
        end if;
    end process;
end behav;

```

Verilog

```
module dff_sync_pre (data, clk, preset, q);
    input data, clk, preset;
    output q;
    reg q;
    always @ (posedge clk)
        if (~preset)
            q = 1'b1;
        else q = data;
endmodule
```

Rising Edge Flip-Flop with Asynchronous Reset and Clock Enable

The following examples infer a D type flip-flop with an asynchronous reset and clock enable.

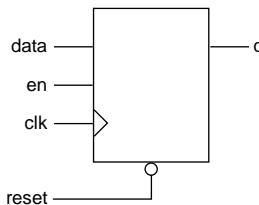

Figure 2-7. D Flip-Flop with Asynchronous Reset and Clock Enable

VHDL

```
library IEEE;
use IEEE.std_logic_1164.all;

entity dff_ck_en is
    port (data, clk, reset, en : in std_logic;
          q : out std_logic);
end dff_ck_en;

architecture behav of dff_ck_en is
begin
    process (clk, reset) begin
        if (reset = '0') then
            q <= '0';
        elsif (clk'event and clk = '1') then
            if (en = '1') then
                q <= data;
            end if;
        end if;
    end process;
end behav;
```

Verilog

```

module dff_ck_en (data, clk, reset, en, q);
    input data, clk, reset, en;
    output q;
    reg q;
    always @ (posedge clk or negedge reset)
        if (~reset)
            q = 1'b0;
        else if (en)
            q = data;
endmodule

```

D-Latches

This section describes and gives examples of different types of D-latches.

D-Latch with Data and Enable

The following examples infer a D-latch with data and enable inputs.

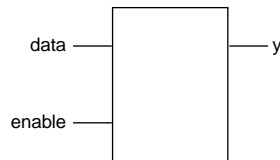

Figure 2-8. D-Latch

VHDL

```

library IEEE;
use IEEE.std_logic_1164.all;

entity d_latch is
    port(enable, data: in std_logic;
         y : out std_logic);
end d_latch;

architecture behave of d_latch is
begin
    process (enable, data)
    begin
        if (enable = '1') then
            y <= data;
        end if;
    end process;
end behave;

```

Verilog

```
module d_latch (enable, data, y);  
    input enable, data;  
    output y;  
    reg y;  
    always @(enable or data)  
        if (enable)  
            y = data;  
endmodule
```

D-Latch with Gated Asynchronous Data

The following examples infer a D-latch with gated asynchronous data.

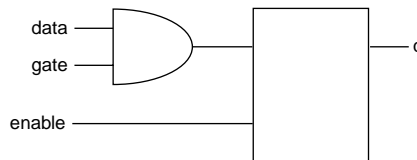

Figure 2-9. D-Latch with Gated Asynchronous Data

VHDL

```
library IEEE;  
use IEEE.std_logic_1164.all;  
  
entity d_latch_e is  
    port (enable, gate, data : in std_logic;  
          q : out std_logic);  
end d_latch_e;  
  
architecture behave of d_latch_e is  
begin  
    process (enable, gate, data) begin  
        if (enable = '1') then  
            q <= data and gate;  
        end if;  
    end process;  
end behave;
```

Verilog

```

module d_latch_e(enable, gate, data, q);
    input enable, gate, data;
    output q;
    reg q;
    always @ (enable or data or gate)
        if (enable)
            q = (data & gate);
endmodule

```

D-Latch with Gated Enable

The following examples infer a D-latch with gated enable.

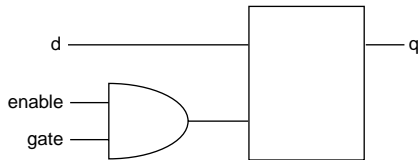

Figure 2-10. D-

VHDL

```

library IEEE;
use IEEE.std_logic_1164.all;

entity d_latch_en is
    port (enable, gate, d: in std_logic;
          q      : out std_logic);
end d_latch_en;

architecture behave of d_latch_en is
begin
    process (enable, gate, d) begin
        if ((enable and gate) = '1') then
            q <= d;
        end if;
    end process;
end behave;

```

Verilog

```
module d_latch_en(enable, gate, d, q);
    input enable, gate, d;
    output q;
    reg q;
    always @ (enable or d or gate)
        if (enable & gate)
            q = d;
endmodule
```

D-Latch with Asynchronous Reset

The following examples infer a D-latch with an asynchronous reset.

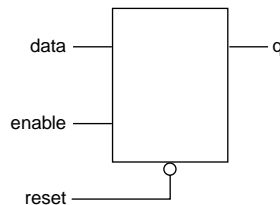

Figure 2-11. D-Latch with Asynchronous Reset

VHDL

```
library IEEE;
use IEEE.std_logic_1164.all;

entity d_latch_rst is
    port (enable, data, reset: in std_logic;
          q : out std_logic);
end d_latch_rst;

architecture behav of d_latch_rst is
begin
    process (enable, data, reset) begin
        if (reset = '0') then
            q <= '0';
        elsif (enable = '1') then
            q <= data;
        end if;
    end process;
end behav;
```

Verilog

```

module d_latch_rst (reset, enable, data, q);
  input reset, enable, data;
  output q;
  reg q;
  always @ (reset or enable or data)
    if (~reset)
      q = 1'b0;
    else if (enable)
      q = data;
endmodule

```

Operators

A number of bit-wise operators are available to the user: Arithmetic, Concentration and Replication, Conditional, Equality, Logical Bit-wise, Logical Comparison, Reduction, Relational, Shift, and Unary Arithmetic (Sign). These operators and their availability in VHDL or Verilog are compared in Table 2-1.

Table 2-1. VHDL and Verilog Operators

Operation	Operator	
	VHDL	Verilog
Arithmetic Operators		
exponential	**	
multiplication	*	*
division	/	/
addition	+	+
subtraction	-	-
modulus	mod	%
remainder	rem	
absolute value	abs	
Concentration and Replication Operators		
concentration	&	{ }
replication		{{ }}
Conditional Operator		
conditional		?:

Table 2-1. VHDL and Verilog Operators (Continued)

Operation	Operator	
	VHDL	Verilog
Equality Operators equality inequality	= /=	== !=
Logical Bit-wise Operators unary negation NOT binary AND binary OR binary NAND binary NOR binary XOR binary XNOR	not and or nand nor xor xnor	~ & ^ ^~ or ~^
Logical Comparison Operators NOT AND OR	not and or	! &&
Reduction Operators AND OR NAND NOR XOR XNOR		& ~& ~ ^ ^~ or ~^
Relational Operators less than less than or equal to greater than greater than or equal to	< <= > >=	< <= > >=
Shift Operators logical shift left logical shift right arithmetic shift left arithmetic shift right logical rotate left logical rotate right	sll srl sla sra rol ror	<< >>
Unary Arithmetic Operators identity negotiation	+ -	+ -

Datapath

Datapath logic is a structured repetitive function. These structures are modeled in various different implementations based on area and timing constraints. Most synthesis tools generate optimal implementations for the target technology.

Priority Encoders Using If-Then-Else

An if-then-else statement is used to conditionally execute sequential statements based on a value. Each condition of the if-then-else statement is checked in order against that value until a true condition is found. Statements associated with the true condition are then executed and the rest of the statement is ignored. If-then-else statements should be used to imply priority on a late arriving signal. In the following examples, shown in Figure 2-12, signal c is a late arriving signal.

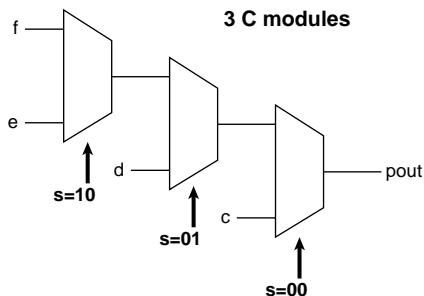

Figure 2-12. Priority

VHDL

```

library IEEE;
use IEEE.std_logic_1164.all;

entity my_if is
port (c, d, e, f: in std_logic;
      s      : in std_logic_vector(1 downto 0);
      pout  : out std_logic);
end my_if;

architecture my_arc of my_if is
begin
myif_pro: process (s, c, d, e, f) begin
    if s = "00" then

```

```
        pout <= c;
    elseif s = "01" then
        pout <= d;
    elseif s = "10" then
        pout <= e;
    else pout <= f;
    end if;
end process myif_pro;
end my_arc;
```

Verilog

```
module IF_MUX (c, d, e, f, s, pout);
    input c, d, e, f;
    input [1:0]s;
    output pout;
    reg pout;
    always @(c or d or e or f or s) begin
        if (s == 2'b00)
            pout = c;
        else if (s ==2'b01)
            pout = d;
        else if (s ==2'b10)
            pout = e;
        else pout = f;
        end
    end
endmodule
```

Multiplexors Using Case

A case statement implies parallel encoding. Use a case statement to select one of several alternative statement sequences based on the value of a condition. The condition is checked against each choice in the case statement until a match is found. Statements associated with the matching choice are then executed. The case statement must include all possible values for a condition or have a default choice to be executed if none of the choices match. The following examples infer multiplexors using a case statement. Refer to “Multiplexors” on page 63 for additional information about using multiplexors with the Actel architecture.

VHDL synthesis tools automatically assume parallel operation without priority in case statements. However, some Verilog tools assume priority, and you may need to add a directive to your case statement to ensure that no priority is assumed. refer to the documentation provided with your synthesis tool for information about creating case statements without priority.

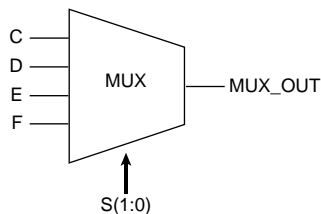

Figure 2-13. Multiplexor Using a Case Statement

4:1 Multiplexor

The following examples infer a 4:1 multiplexor using a case statement.

VHDL

```
--4:1 Multiplexor
library IEEE;
use IEEE.std_logic_1164.all;

entity mux is
port (c, d, e, f : in std_logic;
      s          : in std_logic_vector(1 downto 0);
      muxout     : out std_logic);
end mux;

architecture my_mux of mux is
begin
mux1: process (s, c, d, e, f) begin
  case s is
    when "00" => muxout <= c;
    when "01" => muxout <= d;
    when "10" => muxout <= e;
    when others => muxout <= f;
  end case;
end process mux1;
end my_mux;
```

Verilog

```
//4:1 Multiplexor
module MUX (C, D, E, F, S, MUX_OUT);
  input C, D, E, F;
  input [1:0] S;
  output MUX_OUT;
  reg MUX_OUT;
  always @(C or D or E or F or S)
  begin
    case (S)
      2'b00 : MUX_OUT = C;
      2'b01 : MUX_OUT = D;
      2'b10 : MUX_OUT = E;
      default : MUX_OUT = F;
    endcase
  end
endmodule
```

12:1 Multiplexor

The following examples infer a 12:1 multiplexor using a case statement.

VHDL

```
-- 12:1 mux
library ieee;
use ieee.std_logic_1164.all;

-- Entity declaration:
entity mux12_1 is
port
(
  mux_sel:    in std_logic_vector (3 downto 0);-- mux select
  A:         in std_logic;
  B:         in std_logic;
  C:         in std_logic;
  D:         in std_logic;
  E:         in std_logic;
  F:         in std_logic;
  G:         in std_logic;
  H:         in std_logic;
  I:         in std_logic;
  J:         in std_logic;
  K:         in std_logic;
  M:         in std_logic;
  mux_out:   out std_logic  -- mux output
);
end mux12_1;

-- Architectural body:
architecture synth of mux12_1 is

begin

  procl: process (mux_sel, A, B, C, D, E, F, G, H, I, J, K, M)

  begin

    case mux_sel is
      when "0000"    => mux_out<= A;
      when "0001"    => mux_out <= B;
      when "0010"    => mux_out <= C;
      when "0011"    => mux_out <= D;
      when "0100"    => mux_out <= E;
      when "0101"    => mux_out <= F;
```

```
        when "0110"      => mux_out <= G;
        when "0111"      => mux_out <= H;
        when "1000"      => mux_out <= I;
        when "1001"      => mux_out <= J;
        when "1010"      => mux_out <= K;
        when "1011"      => mux_out <= M;
        when others      => mux_out <= '0';

    end case;
end process procl;

end synth;
```

Verilog

```
// 12:1 mux
module mux12_1(mux_out,
              mux_sel,M,L,K,J,H,G,F,E,D,C,B,A
              );

output      mux_out;
input      [3:0] mux_sel;
input      M;
input      L;
input      K;
input      J;
input      H;
input      G;
input      F;
input      E;
input      D;
input      C;
input      B;
input      A;

reg        mux_out;

// create a 12:1 mux using a case statement
always @ ( {mux_sel[3:0]} or M or L or K or J or H or G or F or
E or D or C or B or A)
begin: mux_blk
    case ( {mux_sel[3:0]} ) // synthesis full_case parallel_case
        4'b0000 :    mux_out = A;
        4'b0001 :    mux_out = B;
        4'b0010 :    mux_out = C;
        4'b0011 :    mux_out = D;
        4'b0100 :    mux_out = E;
        4'b0101 :    mux_out = F;
```



```
        4'b0110 :    mux_out = G;
        4'b0111 :    mux_out = H;
        4'b1000 :    mux_out = J;
        4'b1001 :    mux_out = K;
        4'b1010 :    mux_out = L;
        4'b1011 :    mux_out = M;
        4'b1100 :    mux_out = 1'b0;
        4'b1101 :    mux_out = 1'b0;
        4'b1110 :    mux_out = 1'b0;
        4'b1111 :    mux_out = 1'b0;
    endcase
end
endmodule
```

Case X Multiplexor

The following Verilog example infers a multiplexor using a don't care case x statement. Actel does not recommend using don't care case x statements in VHDL. VHDL synthesis tools do not typically support the don't care value as well as Verilog tools.

Verilog

```
//8 bit 4:1 multiplexor with don't care X, 3:1 equivalent mux
module mux4 (a, b, c, sel, q);
input [7:0] a, b, c;
input [1:0] sel;
output [7:0] q;
reg [7:0] q;

always @ (sel or a or b or c)
casesx (sel)
    2'b00: q = a;
    2'b01: q = b;
    2'bx: q = c;
    default: q = c;
endcasesx
endmodule
```

Decoders

Decoders are used to decode data that has been previously encoded using binary or another type of encoding. The following examples infer a 3-8 line decoder with an enable.

VHDL

```
library IEEE;
use IEEE.std_logic_1164.all;

entity decode is
    port ( Ain : in std_logic_vector (2 downto 0);
          En: in std_logic;
          Yout : out std_logic_vector (7 downto 0));
end decode;

architecture decode_arch of decode is
begin
    process (Ain)
    begin
        if (En='0') then
            Yout <= (others => '0');
        else
            case Ain is
                when "000" => Yout <= "00000001";
                when "001" => Yout <= "00000010";
                when "010" => Yout <= "00000100";
                when "011" => Yout <= "00001000";
                when "100" => Yout <= "00010000";
                when "101" => Yout <= "00100000";
                when "110" => Yout <= "01000000";
                when "111" => Yout <= "10000000";
                when others => Yout <= "00000000";
            end case;
        end if;
    end process;
end decode_arch;
```

Verilog

```
module decode (Ain, En, Yout);
    input En;
    input [2:0] Ain;
    output [7:0] Yout;

    reg [7:0] Yout;

    always @ (En or Ain)
```

```
begin
  if (!En)
    Yout = 8'b0;
  else
    case (Ain)
      3'b000 : Yout = 8'b00000001;
      3'b001 : Yout = 8'b00000010;
      3'b010 : Yout = 8'b00000100;
      3'b011 : Yout = 8'b00001000;
      3'b100 : Yout = 8'b00010000;
      3'b101 : Yout = 8'b00100000;
      3'b110 : Yout = 8'b01000000;
      3'b111 : Yout = 8'b10000000;
      default : Yout = 8'b00000000;
    endcase
  end
endmodule
```

Counters

Counters count the number of occurrences of an event that occur either randomly or at uniform intervals. You can infer a counter in your design. However, most synthesis tools cannot infer optimal implementations of counters higher than 8-bits. If your counter is in the critical path of a speed and area critical design, Actel recommends that you use the ACTgen Macro Builder to build a counter. Once generated, instantiate the ACTgen counter in your design. Refer to “ACTgen Counter” on page 77 for examples of ACTgen counter instantiation. The following examples infer different types of counters.

8-bit Up Counter with Count Enable and Asynchronous Reset

The following examples infer an 8-bit up counter with count enable and asynchronous reset.

VHDL

```
library IEEE;
use IEEE.std_logic_1164.all;
use IEEE.std_logic_unsigned.all;
use IEEE.std_logic_arith.all;

entity counter8 is
port (clk, en, rst      : in std_logic;
      count            : out std_logic_vector (7 downto 0));
end counter8;

architecture behav of counter8 is
signal cnt: std_logic_vector (7 downto 0);
begin
process (clk, en, cnt, rst)
begin
    if (rst = '0') then
        cnt <= (others => '0');
    elsif (clk'event and clk = '1') then
        if (en = '1') then
            cnt <= cnt + '1';
        end if;
    end process;
    count <= cnt;
end behav;
```

Verilog

```
module count_en (en, clock, reset, out);
parameter Width = 8;
input clock, reset, en;
output [Width-1:0] out;
reg [Width-1:0] out;

always @(posedge clock or negedge reset)
    if(!reset)
        out = 8'b0;
    else if(en)
        out = out + 1;
endmodule
```

8-bit Up Counter with Load and Asynchronous Reset

The following examples infer an 8-bit up counter with load and asynchronous reset.

VHDL

```

library IEEE;
use IEEE.std_logic_1164.all;
use IEEE.std_logic_unsigned.all;
use IEEE.std_logic_arith.all;

entity counter is
    port (clk, reset, load: in std_logic;
          data: in std_logic_vector (7 downto 0);
          count: out std_logic_vector (7 downto 0));
end counter;

architecture behave of counter is
    signal count_i : std_logic_vector (7 downto 0);
begin
    process (clk, reset)
    begin
        if (reset = '0') then
            count_i <= (others => '0');
        elsif (clk'event and clk = '1') then
            if load = '1' then
                count_i <= data;
            else
                count_i <= count_i + '1';
            end if;
        end if;
    end process;
    count <= count_i;
end behave;

```

Verilog

```

module count_load (out, data, load, clk, reset);
    parameter Width = 8;
    input load, clk, reset;
    input [Width-1:0] data;
    output [Width-1:0] out;
    reg [Width-1:0] out;

    always @(posedge clk or negedge reset)
        if(!reset)
            out = 8'b0;
        else if(load)
            out = data;
        else
            out = out + 1;
endmodule

```

8-bit Up Counter with Load, Count Enable, Terminal Count and Asynchronous Reset

The following examples infer an 8-bit up counter with load, count enable, terminal count, and asynchronous reset.

Verilog

```
module count_load (out, cout, data, load, clk, en, reset);
parameter Width = 8;
input load, clk, en, reset;
input [Width-1:0] data;
output cout; // carry out
output [Width-1:0] out;
reg [Width-1:0] out;

always @(posedge clk or negedge reset)
if(!reset)
out = 8'b0;
else if(load)
out = data;
else if(en)
out = out + 1;
// cout=1 when all out bits equal 1
assign cout = &out;

endmodule
```

N-bit Up Counter with Load, Count Enable, and Asynchronous Reset

The following examples infer an n-bit up counter with load, count enable, and asynchronous reset.

VHDL

```
library IEEE;
use IEEE.std_logic_1164.all;
use IEEE.std_logic_unsigned.all;
use IEEE.std_logic_arith.all;

entity counter is
generic (width : integer := n);
port (data : in std_logic_vector (width-1 downto 0);
load, en, clk, rst : in std_logic;
q : out std_logic_vector (width-1 downto 0));
end counter;
```

```

architecture behave of counter is
signal count : std_logic_vector (width-1 downto 0);
begin
process(clk, rst)
  begin
    if rst = '1' then
      count <= (others => '0');
    elsif (clk'event and clk = '1') then
      if load = '1' then
        count <= data;
      elsif en = '1' then
        count <= count + 1;
      end if;
    end if;
  end process;
  q <= count;
end behave;

```

Arithmetic Operators

Synthesis tools generally are able to infer arithmetic operators for the target technology. The following examples infer addition, subtraction, division and multiplication operators.

VHDL

```

library IEEE;
use IEEE.std_logic_1164.all;
use IEEE.std_logic_arith.all;
use IEEE.std_logic_unsigned.all;

entity arithmetic is
port (A, B: in std_logic_vector(3 downto 0);
      Q1: out std_logic_vector(4 downto 0);
      Q2, Q3: out std_logic_vector(3 downto 0);
      Q4: out std_logic_vector(7 downto 0));
end arithmetic;

architecture behav of arithmetic is
begin
process (A, B)
begin
  Q1 <= ('0' & A) + ('0' & B); --addition
  Q2 <= A - B; --subtraction
  Q3 <= A / B; --division
  Q4 <= A * B; --multiplication
end process;
end behav;

```

If the multiply and divide operands are powers of 2, replace them with shift registers. Shift registers provide speed optimized implementations with large savings in area. For example:

```
Q <= C/16 + C*4;
```

can be represented as:

```
Q <= shr (C, "100") + shl (C, "10");
```

Or

```
VHDL Q <= "0000" & C (8 downto 4) + C (6 downto 0) & "00";
```

The functions “shr” and “shl” are available in the IEEE.std_logic_arith.all library.

Verilog

```
module arithmetic (A, B, Q1, Q2, Q3, Q4);  
  input [3:0] A, B;  
  output [4:0] Q1;  
  output [3:0] Q2, Q3;  
  output [7:0] Q4;  
  reg [4:0] Q1;  
  reg [3:0] Q2, Q3;  
  reg [7:0] Q4;  
always @ (A or B)  
begin  
  Q1 = A + B; //addition  
  Q2 = A - B; //subtraction  
  Q3 = A / 2; //division  
  Q4 = A * B; //multiplication  
end  
endmodule
```

If the multiply and divide operands are powers of 2, replace them with shift registers. Shift registers provide speed optimized implementations with large savings in area. For example:

```
Q = C/16 + C*4;
```

can be represented as:

```
Q = {4b'0000 C[8:4]} + {C[6:0] 2b'00};
```

Relational Operators

Relational operators compare two operands and indicate whether the comparison is true or false. The following examples infer greater than, less than, greater than equal to, and less than equal to comparators. Synthesis tools generally optimize relational operators for the target technology.

VHDL

```

library IEEE;
use IEEE.std_logic_1164.all;
use IEEE.std_logic_arith.all;

entity relational is
port (A, B : in std_logic_vector(3 downto 0);
       Q1, Q2, Q3, Q4 : out std_logic);
end relational;

architecture behav of relational is
begin
process (A, B)
begin
  -- Q1 <= A > B; -- greater than
  -- Q2 <= A < B; -- less than
  -- Q3 <= A >= B; -- greater than equal to
  if (A <= B) then -- less than equal to
    Q4 <= '1';
  else
    Q4 <= '0';
  end if;
end process;
end behav;

```

Verilog

```

module relational (A, B, Q1, Q2, Q3, Q4);
  input [3:0] A, B;
  output Q1, Q2, Q3, Q4;
  reg Q1, Q2, Q3, Q4;

  always @ (A or B)
  begin
    // Q1 = A > B; //greater than
    // Q2 = A < B; //less than
    // Q3 = A >= B; //greater than equal to
    if (A <= B) //less than equal to
      Q4 = 1;
    else
      Q4 = 0;
    end
  endmodule

```

Equality Operator

The equality and non-equality operators indicate a true or false output based on whether the two operands are equivalent or not. The following examples infer equality operators.

VHDL

```
library IEEE;
use IEEE.std_logic_1164.all;

entity equality is
port (
    A: in STD_LOGIC_VECTOR (3 downto 0);
    B: in STD_LOGIC_VECTOR (3 downto 0);
    Q1: out STD_LOGIC;
    Q2: out STD_LOGIC
);
end equality;

architecture equality_arch of equality is
begin
    process (A, B)
    begin
        Q1 <= A = B; -- equality
        if (A /= B) then -- inequality
            Q2 <= '1';
        else
            Q2 <= '0';
        end if;
    end process;
end equality_arch;
```

OR

```
library IEEE;
use IEEE.std_logic_1164.all;

entity equality is
port (
    A: in STD_LOGIC_VECTOR (3 downto 0);
    B: in STD_LOGIC_VECTOR (3 downto 0);
    Q1: out STD_LOGIC;
    Q2: out STD_LOGIC
);
end equality;

architecture equality_arch of equality is
begin
    Q1 <= '1' when A = B else '0'; -- equality
    Q2 <= '1' when A /= B else '0'; -- inequality
end equality_arch;
```

Verilog

```

module equality (A, B, Q1, Q2);
  input [3:0] A;
  input [3:0] B;
  output Q1;
  output Q2;
  reg Q1, Q2;

  always @ (A or B)
  begin
    Q1 = A == B; //equality
    if (A != B) //inequality
      Q2 = 1;
    else
      Q2 = 0;
    end
  endmodule

```

Shift Operators

Shift operators shift data left or right by a specified number of bits. The following examples infer left and right shift operators.

VHDL

```

library IEEE;
use IEEE.std_logic_1164.all;
use IEEE.std_logic_arith.all;
use IEEE.std_logic_unsigned.all;

entity shift is
  port (data : in std_logic_vector(3 downto 0);
        q1, q2 : out std_logic_vector(3 downto 0));
end shift;

architecture rtl of shift is
begin
  process (data)
  begin
    q1 <= shl (data, "10"); -- logical shift left
    q2 <= shr (data, "10"); --logical shift right
  end process;
end rtl;

```

OR

```
library IEEE;
use IEEE.std_logic_1164.all;

entity shift is
port (data : in std_logic_vector(3 downto 0);
      q1, q2 : out std_logic_vector(3 downto 0));
end shift;

architecture rtl of shift is
begin
  process (data)
  begin
    q1 <= data(1 downto 0) & "10"; -- logical shift left
    q2 <= "10" & data(3 downto 2); --logical shift right
  end process;
end rtl;
```

Verilog

```
module shift (data, q1, q2);
  input [3:0] data;
  output [3:0] q1, q2;

  parameter B = 2;
  reg [3:0] q1, q2;

  always @ (data)
  begin
    q1 = data << B; // logical shift left
    q2 = data >> B; //logical shift right
  end
endmodule
```

Finite State Machine

A finite state machine (FSM) is a type of sequential circuit that is designed to sequence through specific patterns of finite states in a predetermined sequential manner. There are two types of FSM, Mealy and Moore. The Moore FSM has outputs that are a function of current state only. The Mealy FSM has outputs that are a function of the current state and primary inputs. An FSM consists of three parts:

1. **Sequential Current State Register:** The register, a set of n-bit flip-flops (state vector flip-flops) clocked by a single clock signal is used to hold the state vector (current state or simply state) of the FSM. A state vector with a length of n-bit has 2^n possible binary patterns, known as state encoding. Often, not all 2^n patterns are needed, so the unused ones should be designed not to occur during normal operation. Alternatively, an FSM with m-state requires at least $\log_2(m)$ state vector flip-flops.
2. **Combinational Next State Logic:** An FSM can only be in one state at any given time, and each active transition of the clock causes it to change from its current state to the next state, as defined by the next state logic. The next state is a function of the FSM's inputs and its current state.
3. **Combinational Output Logic:** Outputs are normally a function of the current state and possibly the FSM's primary inputs (in the case of a Mealy FSM). Often in a Moore FSM, you may want to derive the outputs from the next state instead of the current state, when the outputs are registered for faster clock-to-out timings.

Moore and Mealy FSM structures are shown in Figure 2-14 and Figure 2-15.

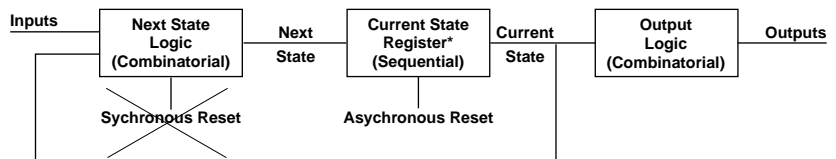

* State Vector Flip-flops

Figure 2-14. Basic Structure of a Moore FSM

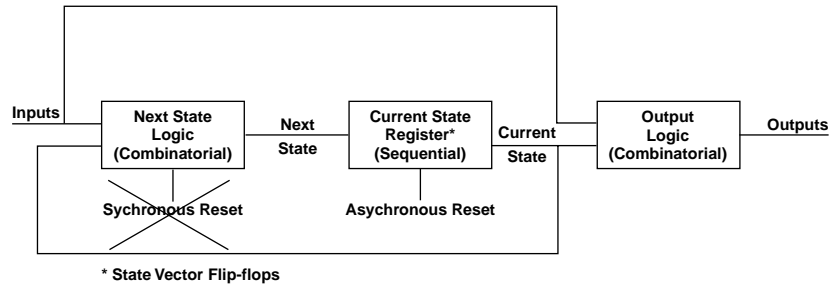

Figure 2-15. Basic Structure of a Mealy FSM

Use a reset to guarantee fail safe behavior. This ensures that the FSM is always initialized to a known valid state before the first active clock transition and normal operation begins. In the absence of a reset, there is no way of predicting the initial value of the state register flip-flops during the “power up” operation of an Actel FPGA. It could power up and become permanently stuck in an unencoded state. The reset should be implemented in the sequential current state process of the FSM description.

An asynchronous reset is generally preferred over a synchronous reset because an asynchronous reset does not require decoding unused states, minimizing the next state logic.

Because FPGA technologies are register rich, “one hot” state machine implementations generated by the synthesis tool may generate optimal area and performance results

Mealy Machine

The following examples represent a Mealy FSM model for the Mealy state diagram shown in Figure 2-16.

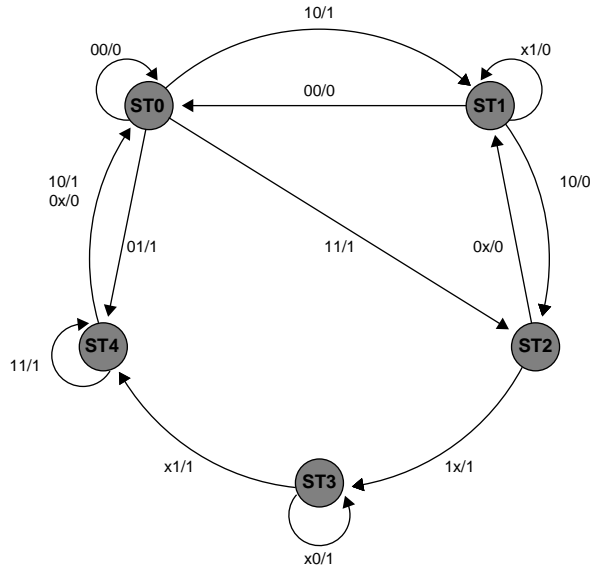

Figure 2-16. Mealy State Diagram

VHDL

```
-- Example of a 5-state Mealy FSM

library ieee;
use ieee.std_logic_1164.all;

entity mealy is
  port (clock, reset: in std_logic;
        data_out: out std_logic;
        data_in: in std_logic_vector (1 downto 0));
end mealy;

architecture behave of mealy is
  type state_values is (st0, st1, st2, st3, st4);
  signal pres_state, next_state: state_values;
begin
  -- FSM register
  statereg: process (clock, reset)
  begin
```

```
    if (reset = '0') then
        pres_state <= st0;
    elsif (clock'event and clock = '1') then
        pres_state <= next_state;
    end if;
end process statereg;

-- FSM combinational block
fsm: process (pres_state, data_in)
begin
    case pres_state is
        when st0 =>
            case data_in is
                when "00" => next_state <= st0;
                when "01" => next_state <= st4;
                when "10" => next_state <= st1;
                when "11" => next_state <= st2;
                when others => next_state <= (others <= 'x');
            end case;
        when st1 =>
            case data_in is
                when "00" => next_state <= st0;
                when "10" => next_state <= st2;
                when others => next_state <= st1;
            end case;
        when st2 =>
            case data_in is
                when "00" => next_state <= st1;
                when "01" => next_state <= st1;
                when "10" => next_state <= st3;
                when "11" => next_state <= st3;
                when others => next_state <= (others <= 'x');
            end case;
        when st3 =>
            case data_in is
                when "01" => next_state <= st4;
                when "11" => next_state <= st4;
                when others => next_state <= st3;
            end case;
        when st4 =>
            case data_in is
                when "11" => next_state <= st4;
                when others => next_state <= st0;
            end case;
        when others => next_state <= st0;
    end case;
end process fsm;
```



```

-- Mealy output definition using pres_state w/ data_in
outputs: process (pres_state, data_in)
begin
    case pres_state is
    when st0 =>
        case data_in is
        when "00" => data_out <= '0';
        when others => data_out <= '1';
        end case;
    when st1 => data_out <= '0';
    when st2 =>
        case data_in is
        when "00" => data_out <= '0';
        when "01" => data_out <= '0';
        when others => data_out <= '1';
        end case;
    when st3 => data_out <= '1';
    when st4 =>
        case data_in is
        when "10" => data_out <= '1';
        when "11" => data_out <= '1';
        when others => data_out <= '0';
        end case;
    when others => data_out <= '0';
    end case;
end process outputs;

end behave;

```

Verilog

```

// Example of a 5-state Mealy FSM

module mealy (data_in, data_out, reset, clock);
output data_out;
input [1:0] data_in;
input reset, clock;

reg data_out;
reg [2:0] pres_state, next_state;

parameter st0=3'd0, st1=3'd1, st2=3'd2, st3=3'd3, st4=3'd4;

// FSM register
always @ (posedge clock or negedge reset)
begin: statereg
if(!reset)// asynchronous reset

```

```
pres_state = st0;
    else
        pres_state = next_state;
    end // statereg

// FSM combinational block
always @(pres_state or data_in)
    begin: fsm
        case (pres_state)
            st0:    case(data_in)
                2'b00:    next_state=st0;
                2'b01:    next_state=st4;
                2'b10:    next_state=st1;
                2'b11:    next_state=st2;
            endcase
            st1:    case(data_in)
                2'b00:    next_state=st0;
                2'b10:    next_state=st2;
                default:  next_state=st1;
            endcase
            st2:    case(data_in)
                2'b0x:    next_state=st1;
                2'bx:    next_state=st3;
            endcase
            st3:    case(data_in)
                2'bx1:    next_state=st4;
                default:  next_state=st3;
            endcase
            st4:    case(data_in)
                2'b11:    next_state=st4;
                default:  next_state=st0;
            endcase
        default:    next_state=st0;
        endcase
    end // fsm

// Mealy output definition using pres_state w/ data_in
always @(data_in or pres_state)
    begin: outputs
        case(pres_state)
            st0:    case(data_in)
                2'b00:    data_out=1'b0;
                default:  data_out=1'b1;
            endcase
            st1:    data_out=1'b0;
            st2:    case(data_in)
```

```

        2'b0x:      data_out=1'b0;
        default:   data_out=1'b1;
    endcase
    st3:          data_out=1'b1;
    st4:          case(data_in)
        2'b1x:      data_out=1'b1;
        default:    data_out=1'b0;
    endcase
    default:      data_out=1'b0;
endcase
end // outputs

endmodule

```

Moore Machine

The following examples represent a Moore FSM model for the Mealy state diagram shown in Figure 2-16 on page 39.

VHDL

```

-- Example of a 5-state Moore FSM

library ieee;
use ieee.std_logic_1164.all;

entity moore is
    port (clock, reset: in std_logic;
          data_out: out std_logic;
          data_in: in std_logic_vector (1 downto 0));
end moore;

architecture behave of moore is
    type state_values is (st0, st1, st2, st3, st4);
    signal pres_state, next_state: state_values;
begin
    -- FSM register
    statereg: process (clock, reset)
    begin
        if (reset = '0') then
            pres_state <= st0;
        elsif (clock = '1' and clock'event) then
            pres_state <= next_state;
        end if;
    end process statereg;

```

```
-- FSM combinational block
fsm: process (pres_state, data_in)
begin
  case pres_state is
    when st0 =>
      case data_in is
        when "00" => next_state <= st0;
        when "01" => next_state <= st4;
        when "10" => next_state <= st1;
        when "11" => next_state <= st2;
        when others => next_state <= (others <= 'x');
      end case;
    when st1 =>
      case data_in is
        when "00" => next_state <= st0;
        when "10" => next_state <= st2;
        when others => next_state <= st1;
      end case;
    when st2 =>
      case data_in is
        when "00" => next_state <= st1;
        when "01" => next_state <= st1;
        when "10" => next_state <= st3;
        when "11" => next_state <= st3;
        when others => next_state <= (others <= 'x');
      end case;
    when st3 =>
      case data_in is
        when "01" => next_state <= st4;
        when "11" => next_state <= st4;
        when others => next_state <= st3;
      end case;
    when st4 =>
      case data_in is
        when "11" => next_state <= st4;
        when others => next_state <= st0;
      end case;
    when others => next_state <= st0;
  end case;
end process fsm;

-- Moore output definition using pres_state only
outputs: process (pres_state)
begin
  case pres_state is
    when st0 => data_out <= '1';
    when st1 => data_out <= '0';
  end case;
end process outputs;
```

```

        when st2    => data_out <= '1';
        when st3    => data_out <= '0';
        when st4    => data_out <= '1';
        when others => data_out <= '0';
    end case;
end process outputs;

end behave;

```

Verilog

```

// Example of a 5-state Moore FSM

module moore (data_in, data_out, reset, clock);
    output data_out;
    input [1:0] data_in;
    input reset, clock;

    reg data_out;
    reg [2:0] pres_state, next_state;

    parameter st0=3'd0, st1=3'd1, st2=3'd2, st3=3'd3, st4=3'd4;

//FSM register
always @(posedge clock or negedge reset)
begin: statereg
    if(!reset)
        pres_state = st0;
    else
        pres_state = next_state;
end // statereg

// FSM combinational block
always @(pres_state or data_in)
begin: fsm
    case (pres_state)
        st0:    case(data_in)
            2'b00:    next_state=st0;
            2'b01:    next_state=st4;
            2'b10:    next_state=st1;
            2'b11:    next_state=st2;
        endcase
        st1:    case(data_in)
            2'b00:    next_state=st0;
            2'b10:    next_state=st2;
            default:    next_state=st1;
        endcase
    endcase
end

```

```
st2:    case(data_in)
        2'b0x:    next_state=st1;
        2'b1x:    next_state=st3;
    endcase
st3:    case(data_in)
        2'bx1:    next_state=st4;
        default:  next_state=st3;
    endcase
st4:    case(data_in)
        2'b11:    next_state=st4;
        default:  next_state=st0;
    endcase
default: next_state=st0;
endcase
end // fsm

// Moore output definition using pres_state only
always @(pres_state)
begin: outputs
    case(pres_state)
        st0:    data_out=1'b1;
        st1:    data_out=1'b0;
        st2:    data_out=1'b1;
        st3:    data_out=1'b0;
        st4:    data_out=1'b1;
        default: data_out=1'b0;
    endcase
end // outputs

endmodule // Moore
```

Input-Output Buffers

You can infer or instantiate a I/O buffers in your design. The following examples represent both techniques. Regardless of which method you use, all I/O buffers should be declared at the top level of the design.

Tri-State Buffer

A tri-state buffer is an output buffer with high-impedance capability. The following examples show how to infer and instantiate a tri-state buffer.

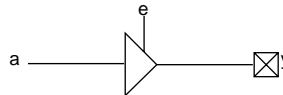

Figure 2-17. Tri-State Buffer

Inference

VHDL

```

library IEEE;
use IEEE.std_logic_1164.all;

entity tristate is
port (e, a : in std_logic;
      y : out std_logic);
end tristate;

architecture tri of tristate is
begin
  process (e, a)
  begin
    if e = '1' then
      y <= a;
    else
      y <= 'Z';
    end if;
  end process;
end tri;

```

OR

```

library IEEE;
use IEEE.std_logic_1164.all;

entity tristate is
port (e, a : in std_logic;
      y : out std_logic);
end tristate;

architecture tri of tristate is
begin
  Y <= a when (e = '1') else 'Z';
end tri;

```

```
end tri;
```

Verilog

```
module TRISTATE (e, a, y);
  input a, e;
  output y;
  reg y;
  always @ (e or a) begin
    if (e)
      y = a;
    else
      y = 1'bz;
    end
endmodule
```

OR

```
module TRISTATE (e, a, y);
  input a, e;
  output y;

  assign y = e ? a : 1'bz;

endmodule
```

Instantiation

VHDL

```
library IEEE;
use IEEE.std_logic_1164.all;

entity tristate is
  port (e, a : in std_logic;
        y : out std_logic);
end tristate;

architecture tri of tristate is

  component TRIBUFF
    port (D, E: in std_logic;
          PAD: out std_logic);
  end component;

begin
  U1: TRIBUFF port map (D => a,
                       E => e,
```



```

        PAD => y);
    end tri;

```

Verilog

```

module TRISTATE (e, a, y);
input a, e;
output y;

    TRIBUFF U1 (.D(a), .E(e), .PAD(y));

endmodule

```

Bi-Directional Buffer

A bi-directional buffer can and input or output buffer with high impedance capability. The following examples show how to infer and instantiate a bi-directional buffer.

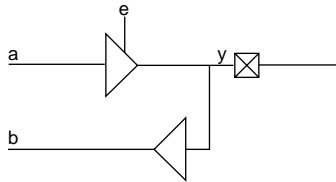

Figure 2-18. Bi-Directional Buffer

Inference

VHDL

```

library IEEE;
use IEEE.std_logic_1164.all;

entity bidir is
port (y : inout std_logic;
       e, a: in std_logic;
       b : out std_logic);
end bidir;

architecture bi of bidir is

begin
    process (e, a)
    begin
        case e is
            when '1' => y <= a;
            when '0' => y <= 'Z';
            when others => y <= 'X';

```

```
        end case;  
    end process;  
    b <= y;  
end bi;
```

Verilog

```
module bidir (e, y, a, b);  
    input a, e;  
    inout y;  
    output b;  
    reg y_int;  
    wire y, b;  
  
    always @ (a or e)  
    begin  
        if (e == 1'b1)  
            y_int <= a;  
        else  
            y_int <= 1'bz;  
        end  
    assign y = y_int;  
    assign b = y;  
endmodule
```

Instantiation

VHDL

```
library IEEE;  
use IEEE.std_logic_1164.all;  
  
entity bidir is  
    port (y : inout std_logic;  
          e, a: in std_logic;  
          b : out std_logic);  
end bidir;  
  
architecture bi of bidir is  
  
    component BIBUF  
        port (D, E: in std_logic;  
              Y : out std_logic;  
              PAD: inout std_logic);  
    end component;  
  
begin
```

```

U1: BIBUF port map (D => a,
                   E => e,
                   Y => b,
                   PAD => y);
end bi;

```

Verilog

```

module bidir (e, y, a, b);
    input a, e;
    inout y;
    output b;

    BIBUF U1 ( .PAD(y), .D(a), .E(e), .Y(b) );
endmodule

```

Generics and Parameters

Generics and parameters are used to define the size of a component. This allows the design of parameterized components for which size and feature sets may be defined by values of the instantiation parameters. The following examples show how to use generics and parameters when describing a parameterized adder. Furthermore, this adder is instantiated for varying widths.

VHDL

```

library IEEE;
use IEEE.std_logic_1164.all;
use IEEE.std_logic_arith.all;
use IEEE.std_logic_unsigned.all;

entity adder is
    generic (WIDTH : integer := 8);
    port (A, B: in UNSIGNED(WIDTH-1 downto 0);
          CIN: in std_logic;
          COUT: out std_logic;
          Y: out UNSIGNED(WIDTH-1 downto 0));
end adder;

architecture rtl of adder is
begin
    process (A,B,CIN)
        variable TEMP_A,TEMP_B,TEMP_Y:UNSIGNED(A'length downto 0);
        begin

```

```
        TEMP_A := '0' & A;
        TEMP_B := '0' & B;
        TEMP_Y := TEMP_A + TEMP_B + CIN;
        Y <= TEMP_Y (A'length-1 downto 0);
        COUT <= TEMP_Y (A'length);
    end process;
end rtl;
```

“Width” indicates the width of the adder. The instantiation for this parameterized adder for a bit width of 16 is:

```
U1: adder generic map(16) port map (A_A, B_A, CIN_A, COUT_A,
Y_A);
```

Verilog

```
module adder (cout, sum, a, b, cin);
    parameter Size = 8;
    output cout;
    output [Size-1:0] sum;
    input cin;
    input [Size-1:0] a, b;

    assign {cout, sum} = a + b + cin;

endmodule
```

“Size” indicates the width of the adder. The instantiation for this parameterized adder for a bit width of 16 is:

```
adder #(16) adder16(cout_A, sun_A, a_A, b_A, cin_A)
```

Performance Driven Coding

Unlike ASICs, FPGAs are module based arrays. Each logic level used on a path can add delay. As a result, meeting timing constraints on a critical path with too many logic levels becomes difficult. Using an efficient coding style is very important because it dictates the synthesis logic implementation. This chapter describes synthesis implementations, techniques, and efficient design practices that can be used to reduce logic levels on a critical path.

Reducing Logic Levels on Critical Paths

Each logic level on the critical path in an FPGA can add significant delay. To ensure that timing constraints can be met, logic level usage must be considered when describing the behavior of a design. The following examples illustrate how to reduce logic levels on critical paths.

Example 1

In the following VHDL example, the signal “critical” goes through three logic levels.

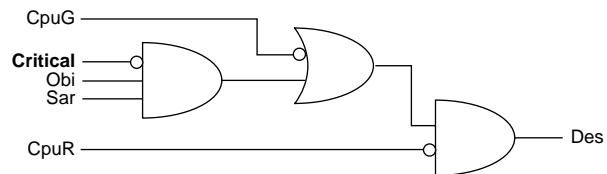

```

if ((( Critical='0' and Obi='1' and Sar='1')
or CpuG='0') and CpuR='0') then
  Des <= Adr;
elsif (((Critical='0' and Obi='1' and Sar='1')
or CpuG='0') and CpuR='1') then
  Des <= Bdr;
elsif (Sar='0' and .....

```

The signal “critical” is a late arriving signal. To reduce the logic level usage on “critical”, imply priority by using an if-then-else statement. As a result, the signal “critical” goes through one logic level, as shown below.

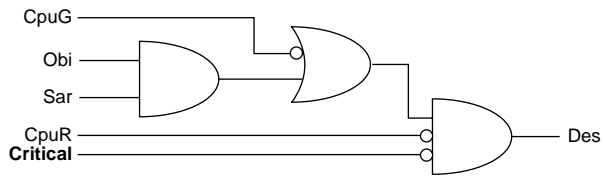

```
if (Critical='0') then
  if (((Obi='1' and Sar='1')
    or CpuG='0') and CpuR='0') then
    Des <= ADR;
  elsif (((Obi='1' and Sar='1')
    or CpuG='0' and CpuR='1') then
    Des <= BDR;
  end if;
end if;
```

Example 2

In the following example, the signal “critical” goes through two logic levels.

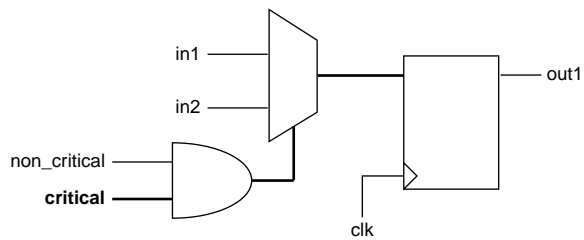

```
if (clk'event and clk = '1') then
  if (non_critical and critical) then
    out1 <= in1
  else
    out1 <= in2
  end if;
end if;
```

To reduce the logic level usage on “critical”, multiplex inputs “in1” and “in2” based on “non_critical”, and call this output “out_temp”. Then multiplex “out_temp” and “in2” based on “critical”. As a result, the signal “critical” goes through one logic level, as shown below.

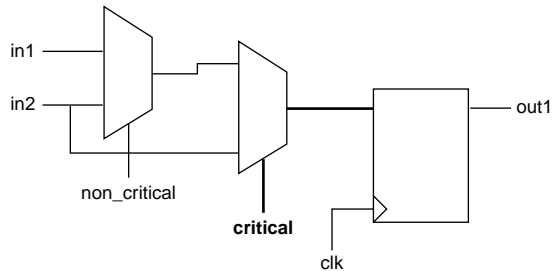

```

signal out_temp : std_logic
if (non_critical)
  out_temp <= in1;
else out_temp <= in2;
if (clk'event and clk = '1') then
  if (critical) then
    out1 <= out_temp;
  else out1 <= in2;
  end if;
end if;
end if;

```

Resource Sharing

Resource sharing can reduce the number of logic modules needed to implement HDL operations. Without it, each HDL description is built into a separate circuit. The following VHDL examples illustrate how to use resource sharing to reduce logic module utilization.

Example 1

This example implements four adders.

```

if (...(siz == 1)...)
  count = count + 1;
else if (...(siz ==2)...)
  count = count + 2;
else if (...(siz == 3)...)
  count = count + 3;
else if (...(siz == 0)...)
  count = count + 4;

```

By adding the following code, two adders can be eliminated:

```
if (...(siz == 0)...)  
    count = count + 4;  
else if (...)  
    count = count + siz
```

Example 2

This example uses poor resource sharing to implement adders.

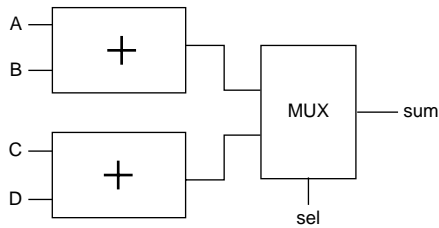

```
if (select)  
    sum <= A + B;  
else  
    sum <= C + D;
```

Adders use valuable resources. To reduce resource usage, rewrite the code to infer two multiplexers and one adder, as shown below.

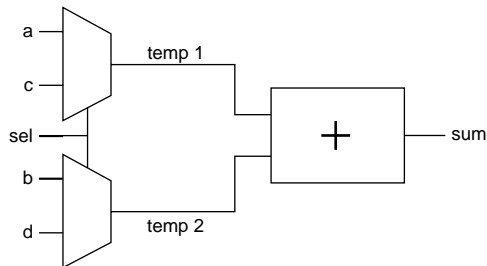

```
if (sel)  
    temp1 <= A;  
    temp2 <= B;  
else  
    temp1 <= C;  
    temp2 <= D;  
sum <= temp1 + temp2;
```

Note: This example assumes the select line is not a late arriving signal.

Operators Inside Loops

Operators are resource intensive compared to multiplexors. If there is an operator inside a loop, the synthesis tool has to evaluate all conditions. In the following VHDL example, the synthesis tool builds four adders and one multiplexor. This implementation is only advisable if the select line “req” is a late arriving signal.

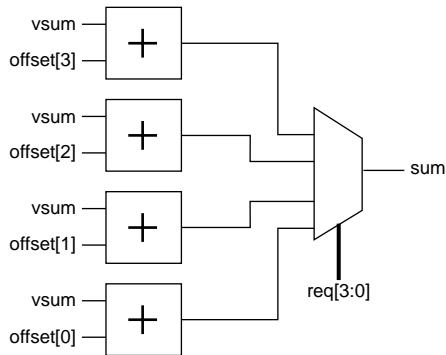

```
vsum := sum;
for i in 0 to 3 loop
  if (req(i)='1') then
    vsum <= vsum + offset(i);
  end if;
end loop;
```

If the select line “req” is not critical, the operator should be moved outside the loop so the synthesis tool can multiplex the data before performing the adder operation. The area efficient design is implemented in a larger multiplexor and a single adder, as shown below.

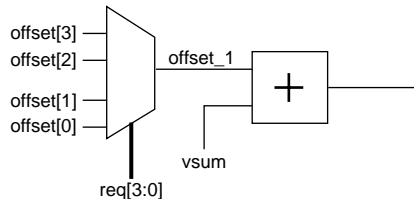

```
vsum := sum;
for i in 0 to 3 loop
  if (req(i)='1') then
    offset_1 <= offset(i);
  end if;
end loop;
vsum <= vsum + offset_1;
```

Coding for Combinability

Combinatorial modules can be merged into sequential modules in the antifuse architecture. This results in a significant reduction in delay on the critical path as well as area reduction. However, cells are only merged if the combinatorial module driving a basic flip-flop has a load of 1. In the following VHDL example, the AND gate driving the flip-flop has a load of 2. As a result, the AND gate cannot be merged into the sequential module.

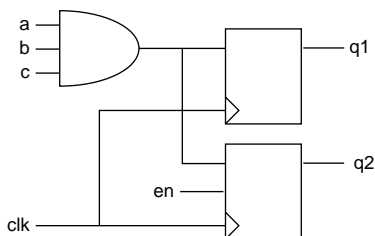

```
one :process (clk, a, b, c, en) begin
  if (clk'event and clk = '1') then
    if (en = '1') then
      q2 <= a and b and c;
    end if;
    q1 <= a and b and c;
  end if;
end process one;
```

To enable merging, the AND gate has to be duplicated so that it has a load of 1. To duplicate the AND gate, create two independent processes, as shown below. Once merged, one logic level has been removed from the critical path.

Note: Some synthesis tools automatically duplicate logic on the critical path. Other synthesis tools detect the function “a & b & c” in the two processes and share the function on a single gate. If the function is shared, the logic is not duplicated and instantiation should be considered.

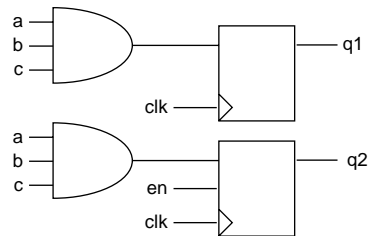

```

part_one: process (clk, a, b, c, en) begin
if (clk'event and clk = '1') then
    if (en = '1') then
        q2 <= a and b and c;
    end if;
end if;
end process part_one;
part_two: process (clk, a, b, c) begin
if (clk'event and clk = '1') then
    q1 <= a and b and c;
end if;
end process part_two;

```

Register Duplication

The delay on a net rises as the number of loads increase in the antifuse architecture. This may be acceptable for networks such as reset, but not others such as tri-state enable, etc. It is important to keep the fanout of a network below 16. In the following VHDL example, the signal “Tri_en” has a fanout of 24.

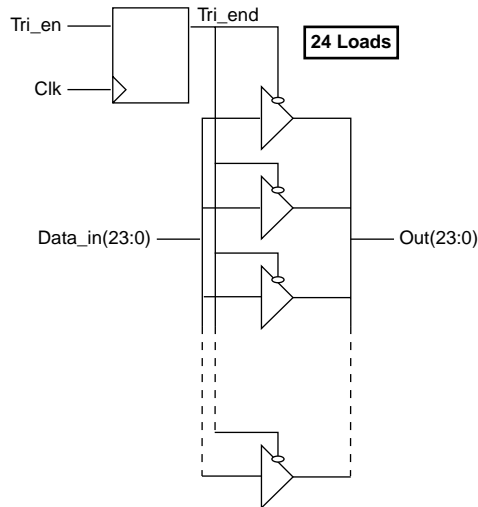

```

architecture load of four_load is
    signal Tri_en std_logic;
begin
loadpro: process (Tri_en, Clk)
    begin
        if (clk'event and clk = '1') then
            Tri_end <= Tri_en;
        end if;
    end process loadpro;

endpro : process (Tri_end, Data_in)
begin
    if (Tri_end = '1') then
        out <= Data_in;
    else
        out <= (others => 'Z');
    end if;
end process endpro;
end load;

```

To decrease the fanout by half, registers are duplicated on the signal “Tri_en” so the load is split in half, as shown in the following example.

Note: Some synthesis tools duplicate registers to resolve timing and fanout violations and do not need to use this coding technique.

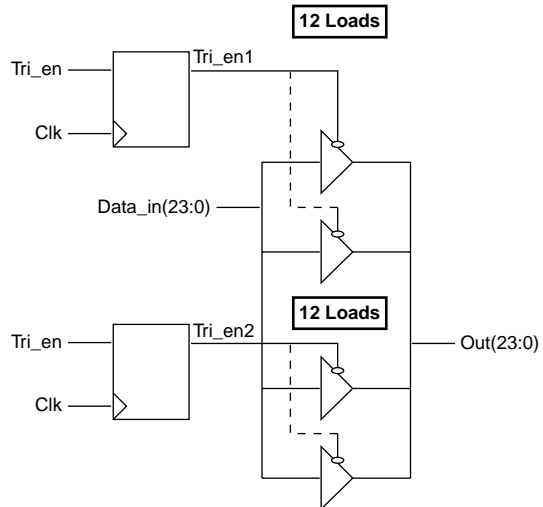

```

architecture loada of two_load is
    signal Tri_en1, Tri_en2 : std_logic;
begin
    loadpro: process (Tri_en, Clk)
    begin
        if (clk'event and clk = '1') then
            Tri_en1 <= Tri_en;
            Tri_en2 <= Tri_en;
        end if;
    end process loadpro;

    process (Tri_en1, Data_in)
    begin
        if (Tri_en1 = '1') then
            out(23:12) <= Data_in(23:12);
        else
            out(23:12) <= (others => 'Z');
        end if;
    end process;

    process (Tri_en2, Data_in)
    begin
        if (Tri_en2 = '1') then
            out(11:0) <= Data_in(11:0);
        else
            out(11:0) <= (others => 'Z');
        end if;
    end process;
end architecture loada;

```

Partitioning a Design

Most synthesis tools work best when optimizing medium size blocks, approximately two to five thousand gates at a time. To reduce synthesis time, you should partition designs so that module block sizes do not exceed the recommendations of the synthesis tool vendor. When partitioning a design into various blocks, it is good design practice to have registers at hierarchical boundaries. This eliminates the need for time budgeting on the inputs and outputs. The following example shows how to modify your HDL code so that registers are placed at hierarchical boundaries.

Registers Embedded Within a Module

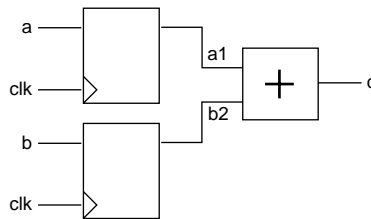

```
process (clk, a, b) begin
    if (clk'event and clk = '1') then
        a1 <= a;
        b1 <= b;
    end if;
end process;

process (a1, b1)
begin c <= a1 + b1;
end process;
```

Registers Pushed Out at the Hierarchical Boundary

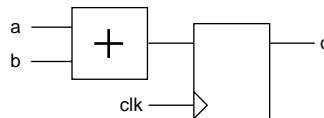

```
process (clk, a, b) begin
    if (clk'event and clk = '1') then
        c <= a + b;
    end if;
end process;
```

Technology Specific Coding Techniques

In addition to technology independent coding and performance driven coding, there are coding techniques that can be used to take advantage of the Actel architecture to improve speed and area utilization of your design. Additionally, most synthesis tools can implement random logic, control logic and certain datapath macros. However, they may not generate technology optimal implementations for datapath elements that cannot be inferred using operators, such as counters, RAM, FIFO, etc. This chapter describes coding techniques to take advantage of technology specific features and how to instantiate technology specific macros generated by the ACTgen Macro Builder tool for optimal area and performance.

Multiplexors

Using case statements with the multiplexor based Actel architecture provides area and speed efficient solutions and is more efficient than inference of priority encoders using if-then-else statements. Actel recommends that you use case statements instead of long, nested if-then-else statements to force mapping to multiplexors in the Actel architecture. Refer to “Multiplexors Using Case” on page 21 for examples of multiplexor coding.

VHDL synthesis tools automatically assume parallel operation without priority in case statements. However, some Verilog tools assume priority, and you may need to add a directive to your case statement to ensure that no priority is assumed. Refer to the documentation provided with your synthesis tool for information about creating case statements without priority.

Internal Tri-State to Multiplexor Mapping

All internal tri-states must be mapped to multiplexors. The antifuse technology only supports tri-states as in/out ports, but not internal tri-states. The following examples show an internal tri-state followed by a multiplexor that the internal tri-state should be changed to.

Note: Some synthesis tools automatically map internal tri-states to multiplexors.

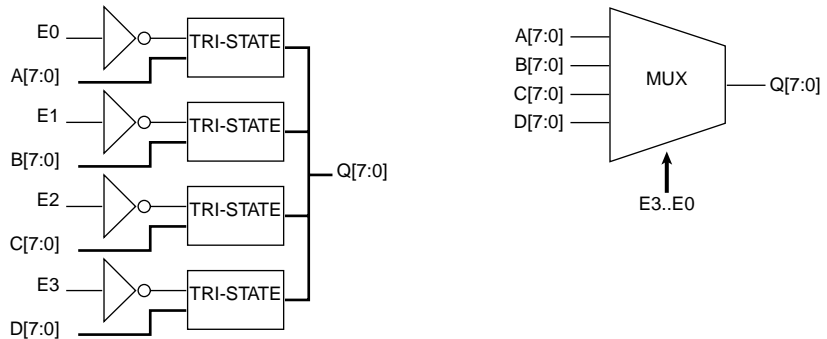

VHDL Tri-State

```
library IEEE;
use IEEE.std_logic_1164.all;
entity tribus is
port (A, B, C, D : in std_logic_vector(7 downto 0);
E0, E1, E2, E3 : in std_logic;
Q : out std_logic_vector(7 downto 0));
end tribus;

architecture rtl of tribus is
begin
Q <= A when (E0 = '1') else "ZZZZZZZZ";
Q <= B when (E1 = '1') else "ZZZZZZZZ";
Q <= C when (E2 = '1') else "ZZZZZZZZ";
Q <= D when (E3 = '1') else "ZZZZZZZZ";
end rtl;
```

VHDL Multiplexor

```

library IEEE;
use IEEE.std_logic_1164.all;
entity muxbus is
port (A, B, C, D : in std_logic_vector(7 downto 0);
E0, E1, E2, E3 : in std_logic;
Q : out std_logic_vector(7 downto 0));
end muxbus;

architecture rtl of muxbus is
signal E_int : std_logic_vector(1 downto 0);
begin
process (E0, E1, E2, E3)
variable E : std_logic_vector(3 downto 0);
begin
E := E0 & E1 & E2 & E3;
case E is
when "0001" => E_int <= "00";
when "0010" => E_int <= "01";
when "0100" => E_int <= "10";
when "1000" => E_int <= "11";
when others => E_int <= "--";
end case;
end process;

process (E_int, A, B, C, D)
begin
case E_int is
when "00" => Q <= D;
when "01" => Q <= C;
when "10" => Q <= B;
when "11" => Q <= A;
when others => Q <= (others => '-');
end case;
end process;
end rtl;

```

Verilog Tri-State

```

module tribus (A, B, C, D, E0, E1, E2, E3, Q);

input [7:0]A, B, C, D;
output [7:0]Q;
input E0, E1, E2, E3;

assign Q[7:0] = E0 ? A[7:0] : 8'bzzzzzzzz;
assign Q[7:0] = E1 ? B[7:0] : 8'bzzzzzzzz;
assign Q[7:0] = E2 ? C[7:0] : 8'bzzzzzzzz;
assign Q[7:0] = E3 ? D[7:0] : 8'bzzzzzzzz;

endmodule

```

Verilog Multiplexor

```
module muxbus (A, B, C, D, E0, E1, E2, E3, Q);
    input [7:0]A, B, C, D;
    output [7:0]Q;
    input E0, E1, E2, E3;
    wire [3:0] select4;
    reg [1:0] select2;
    reg [7:0]Q;

    assign select4 = {E0, E1, E2, E3};

    always @ (select4)
    begin
        case(select4)
            4'b0001 : select2 = 2'b00;
            4'b0010 : select2 = 2'b01;
            4'b0100 : select2 = 2'b10;
            4'b1000 : select2 = 2'b11;
            default : select2 = 2'bxx;
        endcase
    end

    always @ (select2 or A or B or C or D)
    begin
        case(select2)
            2'b00 : Q = D;
            2'b01 : Q = C;
            2'b10 : Q = B;
            2'b11 : Q = A;
        endcase
    end

endmodule
```

Registers

The XL, DX, MX, and ACT 3 families have dedicated asynchronous reset registers in the sequential modules (SMOD). In each SMOD is a 4:1 multiplexor with some gating logic on the select lines. Implementing a simple register or an asynchronous reset register allows the gating logic in front of the register to be pulled into the SMOD, reducing the path delay by one level. This is called full combinability. Full combinability offers improved speed, increasing a 50MHz operation to 75MHz in some designs. The following examples show how to use registers for combinability and discuss any speed or area penalty associated with using the register.

Synchronous Clear or Preset

The synchronous clear or preset register only uses part of the SMOD multiplexor, allowing for some combinability. The following example shows how to share a synchronous register with a 2:1 multiplexor.

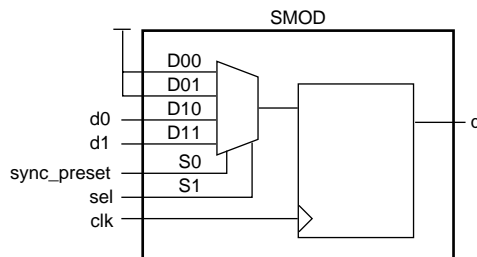

Figure 4-1. Single Module Implementation of a Synchronous Clear or Preset Register

VHDL

```
-- register with active low sync preset shared with a 2-to-1
mux.
```

```
library ieee;
use ieee.std_logic_1164.all;
entity dfm_sync_preset is
PORT (d0, d1: in std_logic;
      clk, preset, sel: in std_logic;
      q: out std_logic;
end dfm_sync_preset;

architecture behav of dfm_sync_preset is
signal tmp_sel: std_logic_vector(1 downto 0);
signal q_tmp: std_logic;
begin
process (clk) begin
tmp_sel <= preset & sel;
if (clk'event and clk = '1') then
case tmp_sel is
when "00" => q_tmp <= '1';
when "01" => q_tmp <= '1';
when "10" => q_tmp <= d0;
when "11" => q_tmp <= d1;
when others => q_tmp <= '1';
end case;
end if;
end process;
q <= q_tmp;
end behav;
```

Verilog

```
/* register with active-low synchronous preset shared with
2-to-1 mux */

module dfm_sync_preset (d0, d1, clk, sync_preset, sel, q);
input d0, d1;
input sel;
input clk, sync_preset;
output q;
reg q;
always @ (posedge clk)
begin
case ({sync_preset, sel})
2'b00: q = 1'b1;
2'b01: q = 1'b1;
2'b10: q = d0;
2'b11: q = d1;
endcase
end
endmodule
```

Clock Enabled

The clock enabled register uses a 2:1 multiplexor with output feedback, which uses some of the SMOD multiplexor. The following example shows how to share a clock enabled register with the input logic.

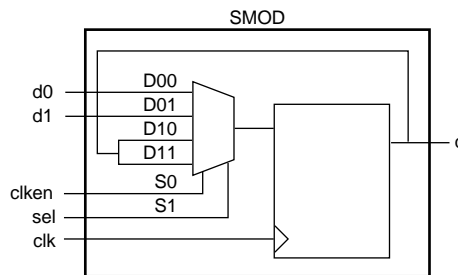

Figure 4-2. Single Module Implementation of a Clock Enabled Register

VHDL

```
-- register with active low async reset, shared with a 2-to-1  
-- mux, and an active high clock enable.
```

```
library ieee;  
use ieee.std_logic_1164.all;  
entity dfm_clken is  
PORT (d0, d1: in std_logic;  
      clk, reset, clken, sel: in std_logic;  
      q: out std_logic;  
end dfm_clken;  
  
architecture behav of dfm_clken is  
signal tmp_sel: std_logic_vector(1 downto 0);  
signal q_tmp: std_logic;  
begin  
process (clk, reset) begin  
    tmp_sel <= clken & sel;  
    if (reset = '0') then  
        q_tmp <= '0';  
    elsif (clk'event and clk = '1') then  
        case tmp_sel is  
            when "00" => q_tmp <= d0;  
            when "01" => q_tmp <= d1;  
            when "10" => q_tmp <= q_tmp;  
            when "11" => q_tmp <= q_tmp;  
            when others => q_tmp <= q_tmp;  
        end case;  
    end if;  
end process;  
q <= q_tmp;  
end behav;
```

Verilog

```
/* register with asynchronous set, clock enable,
shared with a 2-to-1 mux */

module dfm_clken (d0, d1, clk, reset, clken, sel, q);
input d0, d1;
input sel;
input clk, reset, clken;
output q;
reg q;
always @ (posedge clk or negedge reset)
begin
  if (!reset)
    q = 1'b0;
  else
    case ({clken, sel})
      2'b00: q = d0;
      2'b01: q = d1;
      2'b10: q = q;
      2'b11: q = q;
    endcase
end
endmodule
```

Asynchronous Preset

Some synthesis tools automatically translate an asynchronous preset register into an asynchronous reset register without performance penalties. The bubbled logic can then be pushed into the surrounding logic without any delay penalty. There are various types of preset registers in the Actel libraries. Some of the registers use two combinatorial modules (CMOD) and most use an inverter, which consumes part of the SMOD multiplexor. If your synthesis tool does not automatically translate an asynchronous preset register into a functionally equivalent asynchronous preset register using an asynchronous reset register, use the following examples to design an asynchronous reset register.

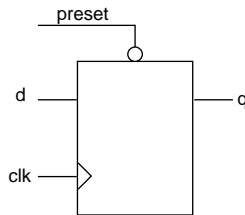

Figure 4-3. Asynchronous Preset

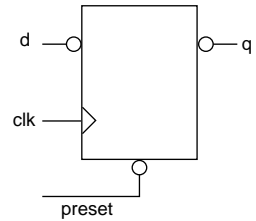

Figure 4-4. Equivalent Asynchronous Preset

Verilog Asynchronous Preset

```
// Active-low async preset flip-flop

module dfp (q, d, clk, preset);
input d, clk, preset;
output q;
reg q;

    always @(posedge clk or negedge preset)
    if (!preset)
        q = 1'b1;
    else
        q = d;
endmodule
```

Verilog Equivalent Asynchronous Preset

```
/* Equivalent active-low async preset flip-flop, using an
async reset flop with bubbled d and q */

module dfp_r (q, d, clk, preset);
input d, clk, preset;
output q;
wire d_inv, reset;
reg q_inv;

assign d_inv = !d;
assign q = !q_inv;
assign reset = preset;
always @(posedge clk or negedge reset)
    if (!reset)
        q_inv = 1'b0;
    else
        q_inv = d_inv;
endmodule
```

VHDL Asynchronous Preset

```
-- register with active low async preset.

library ieee;
use ieee.std_logic_1164.all;
entity dfp is
    port (d, clk, preset : in std_logic;
          q : out std_logic);
end dfp;

architecture behav of dfp is
begin
process (clk, preset) begin
    if (preset = '0') then
        q <= '1';
    elsif (clk'event and clk = '1') then
        q <= d;
    end if;
end process;
end behav;
```

VHDL Equivalent Asynchronous Preset

```
-- register with active low async preset.

library ieee;
use ieee.std_logic_1164.all;
entity dfp_r is
    port (d, clk, preset : in std_logic;
          q : out std_logic);
end dfp_r;

architecture behav of dfp_r is
    signal reset, d_tmp, q_tmp : std_logic;
begin
    reset <= preset;
    d_tmp <= NOT d;
    process (clk, reset) begin
        if (reset = '0') then
            q_tmp <= '0';
        elsif (clk'event and clk = '1') then
            q_tmp <= d_tmp;
        end if;
    end process;
    q <= NOT q_tmp;
end behav;
```

Asynchronous Preset and Clear

This is the most problematic register for the ACT 2, XL, DX, MX, and ACT 3 architectures. Only one cell can be used, the DFPC cell, to design an asynchronous preset and clear register. The DFPC uses two CMODs to form a master latch and a slave latch that together form one register. This uses two CMODs per register and it offers no logic combinability with the SMOD. The DFPC requires more setup time and no combinability. The net timing loss can often be as high as 10ns. Actel recommends that you do not use any asynchronous preset and clear registers on critical paths. Use a synchronous preset with asynchronous clear or a synchronous clear register instead.

An asynchronous preset and clear register can be used if it does not affect a critical path or cause high utilization in the design.

Registered I/Os

The ACT 3 technology has registers in the I/O ring, with both reset and preset, which allow for fast input setup and clock-to-out delays. Because most synthesis tools do not infer these special resources, the following example shows how to instantiate a registered I/O cell, BREPTH, in your design.

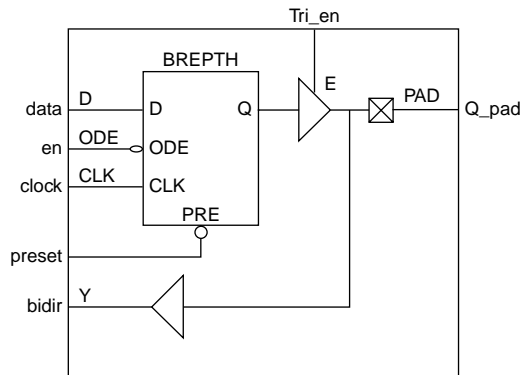

Figure 4-5. Registered I/O Cell

VHDL

```
library IEEE;
use IEEE.std_logic_1164.all;

entity regio is
    port (data, en, Tri_en, clock, preset : in std_logic;
          bidir : inout std_logic;
          q_pad : out std_logic);
end regio;

architecture rtl of regio is

-- Component Declaration
component BREPTH
    port (D, ODE, E, IOPCL, CLK : in std_logic;
          Y : out std_logic;
          PAD : inout std_logic);
end component;

begin
-- Concurrent Statement
U0 : BREPTH port map ( D => data,
                      ODE => en,
                      E => Tri_en,
                      IOPCL => preset,
                      CLK => clock,
                      Y => q_pad,
                      PAD => bidir);

end rtl;
```

Verilog

```
module regio (data, Q_pad, clock, preset, Tri_en, en, bidir);

    input  data, clock, preset, Tri_en, en;
    output Q_pad;
    inout  bidir;

    BREPTH U1 (.PAD(Q_pad), .D(data), .CLK(clock), .IOPCL(preset),
              .E(Tri_en), .ODE(en), .Y(bidir));

endmodule
```

Note: As a good design practice, instantiate all input/output cells at the top level of your design.

CLKINT/CLKBUF for Reset and/or High Fanout Networks

Many designs have internally generated clocks, high fanout control signals, or internally generated reset signals. These signals need a large internal driver, CLKINT, to meet both area and performance goals for the circuit. If the high fanout signals come directly into the design through an I/O, a CLKBUF driver is used. Most synthesis tools do not automatically use these drivers. Instead, the synthesis tool builds a buffer tree that consumes one module per driver. On a high fanout net this can affect both the area and timing for that signal. If the global drivers for a given array are still available, you should instantiate the CLKINT or CLKBUF driver into the design. The following example shows how to instantiate these drivers.

CLKINT

The following examples instantiate the CLKINT driver.

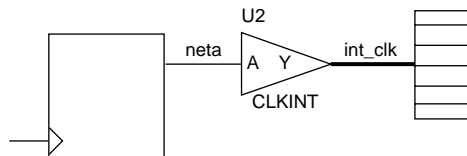

VHDL

```

library IEEE;
use IEEE.std_logic_1164.all;

entity design is
    port (..... : in std_logic;
          ..... : out std_logic);
end design;

    architecture rtl of design is

-- Component Declaration
component CLKINT
    port (A : in std_logic;
          Y : out std_logic);
end component;

begin
-- Concurrent Statement
U2 : CLKINT port map ( A => neta,
                      Y => int_clk);
end rtl;

```

Verilog

```
module design (.....);  
  
    input .....;  
    output .....;  
    CLKINT U2 (.Y(int_rst), .A(neta));  
    .....  
    .....  
endmodule
```

CLKBUF

The following examples instantiate a CLKBUF driver.

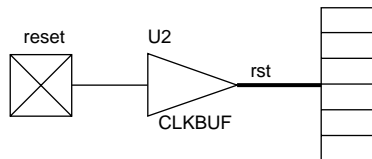

VHDL

```
library IEEE;  
use IEEE.std_logic_1164.all;  
  
entity design is  
port (PAD : in std_logic;  
      Y : out std_logic);  
end component;  
  
begin  
    -- Concurrent Statement  
    U2 : CLKBUF port map (PAD => neta, Y => int_rst);  
end rtl;
```

Verilog

```
module design (.....);  
  
    input .....;  
    output .....;  
    CLKBUF U2 (.Y(rst), .PAD(reset));  
    .....  
    .....  
endmodule
```

QCLKINT/QCLKBUF for Medium Fanout Networks

The 32100DX, 32200DX, 32300DX, and 42MX36 have four quadrant clocks that can be used to drive internally generated high fanout nets (QCLKINT) or high fanout nets generated from I/O ports (QCLKBUF). The methodology and instantiation are similar to the CLKINT/CLKBUF drivers. However, the QCLK drivers can only drive within a quadrant. Although the placement of the cells into a quadrant is automated by the Designer place and rout software, you must limit the number of fanouts and prevent the use of multiple QCLK signals to drive the same cell or gate. Table 4-1 lists fanout limits for the devices.

You can double your fanout limit and drive half the chip by combining two drivers into one to drive 2 quadrants. However, each time you combine drivers, you reduce the number of available QCLKs by one. The Designer place and route software automatically combines QCLKs when necessary.

Table 4-1. Fanout Limits

	32100DX	32200DX 42MX36	32300DX
Quadrant QCLK Fanout Limit	175	307	472
Half Chip QCLK Fanout Limit	350	614	944

ACTgen Counter

Several synthesis tools cannot build an optimal counter implementation for the Actel architecture. If a counter is on a critical path, this implementation can increase logic level usage and decrease performance. To reduce critical path delays and to achieve optimal results from your design, Actel recommends that you instantiate counters generated by the ACTgen Macro Builder. The ACTgen Macro Builder supports a wide variety of counters for area and performance needs.

The following example uses a 5-bit counter with load, count enable, and asynchronous reset that has been generated with ACTgen and saved as a structural HDL netlist called "CNT5". The counter is instantiated as follows:

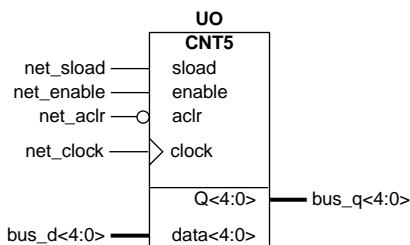

VHDL

```

library IEEE;
use IEEE.std_logic_1164.all;

entity counter is
    port (bus_d : in std_logic_vector(4 downto 0);
          bus_q : out std_logic_vector(4 downto 0);
          net_clock, net_aclr, net_enable : in std_logic;
          net_sload : in std_logic);
end counter;

architecture rtl of counter is

-- Component Declaration
component CNT5
    port (Data : in std_logic_vector(4 downto 0);
          Sload, Enable, Aclr, Clock : in std_logic;
          Q : out std_logic_vector(4 downto 0));
end component;

begin
-- Concurrent Statement
U0 : CNT5 port map (Data => bus_d,
                    Sload => net_sload,
                    Enable => net_enable,
                    Aclr => net_aclr,
                    Clock => net_clock,
                    Q => bus_q);

end rtl;

```

Verilog

```
module counter (bus_q, bus_d, net_clock, net_aclr, net_enable,
               net_sload);
    input [4:0] data;
    input net_sload, net_enable, net_aclr, net_clock;
    output [4:0] bus_q;

    CNT5 U0 (.Q(bus_q), .Data(bus_d), .Clock(net_clock),
            .Aclr(net_aclr), .Enable(net_enable), .Sload(net_sload));
endmodule
```

Dual Architecture Coding in VHDL

It is possible to maintain technology independence after instantiating an ACTgen macro into your design. By adding a second technology independent architecture, you can maintain two functionally equivalent architectures of the same entity in your design. The ACTgen macro is Actel specific and instantiated in your design to take advantage of the architectural features of the target Actel FPGA. This allows you to meet your design goals quickly. The technology independent architecture is functionally equivalent to the Actel specific architecture (verified by simulation) and can be used to synthesize the design to another technology if necessary. The following example shows the technology independent (RTL) and Actel specific (structural) architecture for a counter called “CNT5” and illustrates how to write your code so that you can choose which architecture to use.

RTL Architecture

This implementation of “CNT5” is written as a behavioral description directly into the design.

```
library IEEE;
use IEEE.std_logic_1164.all;
use IEEE.std_logic_unsigned.all;

entity CNT5 is
port    (Data: in std_logic_vector(4 downto 0);
         Sload, Enable, Aclr, Clock: in std_logic;
         Q: out std_logic_vector(4 downto 0));
end CNT5;
```

```
architecture RTL of CNT5 is

signal cnt: std_logic_vector(4 downto 0);

begin
counter : process (Aclr, Clock)
begin
if (Aclr = '0') then
cnt <= (others => '0');           -- asynchronous reset
elsif (Clock'event and Clock = '1') then
if (Sload = '1') then
cnt <= Data;-- synchronous load
elsif (Enable = '1') then
cnt <= cnt + '1';           -- increment counter
end if;
end if;
end process;
Q <= cnt;           -- assign counter output to output port
end RTL;
```

Structural Architecture

This implementation of “CNT5” is created by the ACTgen macro builder. The port names for the RTL description must match the port names of the structural “CNT5” netlist generated by ACTgen.

```
library ieee;
use ieee.std_logic_1164.all;
library ACT3;

entity CNT5 is
port (Data : in std_logic_vector(4 downto 0); Enable, Sload,
Aclr, Clock : in std_logic; Q : out std_logic_vector(4
downto 0)) ;
end CNT5;

architecture DEF_ARCH of CNT5 is

component DFM7A
port(D0, D1, D2, D3, S0, S10, S11, CLR, CLK : in
std_logic; Q : out std_logic);
end component;

. . .

end DEF_ARCH;
```

Instantiating “CNT5” in the Top Level Design

Once you have created both architectures, instantiate “CNT5” into your design, adding binding statements for both architectures. The binding statements are used to specify which architecture the synthesis tool uses in the design. The technology independent RTL architecture might not meet the performance requirements. The Actel specific DEF_ARCH architecture is optimized for the Actel FPGA architecture and may provide higher performance. By removing the comment on one of the “use” statements in the code, a particular architecture can be chosen to meet the design needs.

```

library IEEE;
use IEEE.std_logic_1164.all;

entity counter is
port (bus_d: in std_logic_vector(4 downto 0);
       bus_q: out std_logic_vector(4 downto 0);
       net_clock, net_aclr, net_enable: in std_logic;
       net_sload: in std_logic);
end counter;

architecture rtl of counter is

-- Component Declaration
component CNT5
port (Data : in std_logic_vector(4 downto 0);Enable, Sload,
      Aclr, Clock : in std_logic; Q : out std_logic_vector(4
      downto 0));
end component;

-- Binding statements to specify which CNT5 architecture to use
-- RTL architecture for behavioral CNT5
-- DEF_ARCH architecture for structural (ACTgen) CNT5
-- for all: CNT5 use entity work.CNT5(RTL);
-- for all: CNT5 use entity work.CNT5(DEF_ARCH);

begin
-- Concurrent Statement
U0: CNT5 port map (Data => bus_d,
                  Sload => net_sload,
                  Enable => net_enable,
                  Aclr => net_aclr;
                  Clock => net_clock,
                  Q => bus_q);

end rtl;

```

SRAM

The following examples show how to create register-based SRAM for non-SRAM based Actel devices.

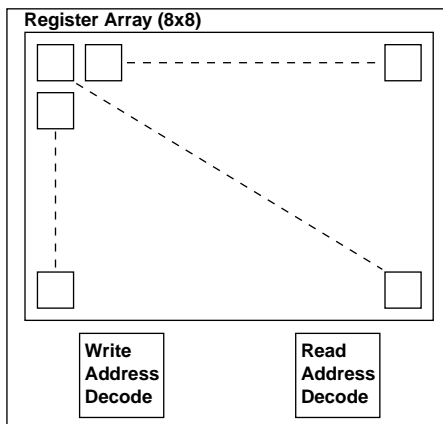

Figure 4-6. R

Register-Based Single Port SRAM

The following example shows the behavioral model for a 8x8 RAM cell. To modify the width or depth, simply modify the listed parameters in the code. The code assumes that you want to use posedge clk and negedge reset. Modify the always blocks if that is not the case.

VHDL

```

-- *****
-- Behavioral description of a single-port SRAM with:
--   Active High write enable (WE)
--   Rising clock edge (Clock)
-- *****

library ieee;
use ieee.std_logic_1164.all;
use IEEE.std_logic_arith.all;
use IEEE.std_logic_unsigned.all;

entity reg_sram is
  generic (width  : integer:=8;
          depth  : integer:=8;
          addr   : integer:=3);

```

```

    port (Data   : in std_logic_vector (width-1 downto 0);
          Q      : out std_logic_vector (width-1 downto 0);
          Clock  : in std_logic;
          WE     : in std_logic;
          Address: in std_logic_vector (addr-1 downto 0));
end reg_sram;

architecture behave of reg_sram is
    type MEM is array (0 to depth-1) of std_logic_vector(width-1
    downto 0);
    signal ramTmp : MEM;
begin
    process (Clock)
    begin
        if (clock'event and clock='1') then
            if (WE = '1') then
                ramTmp (conv_integer (Address)) <= Data;
            end if;
        end if;
    end process;
    Q <= ramTmp(conv_integer(Address));
end behave;

```

Verilog

```

`timescale 1 ns/100 ps
#####
// Behavioral single-port SRAM description :
// Active High write enable (WE)
// Rising clock edge (Clock)
#####

module reg_sram (Data, Q, Clock, WE, Address);

    parameter width = 8;
    parameter depth = 8;
    parameter addr = 3;

    input Clock, WE;
    input [addr-1:0] Address;
    input [width-1:0] Data;
    output [width-1:0] Q;
    wire [width-1:0] Q;
    reg [width-1:0] mem_data [depth-1:0];

    always @(posedge Clock)
        if(WE)
            mem_data[Address] = #1 Data;

    assign Q = mem_data[Address];

endmodule

```

Register-Based Dual-Port SRAM

The following example show the behavioral model for a 8x8 RAM cell. This code was designed to imitate the behavior of the Actel DX family dual-port SRAM and to be synthesizable to a register based SRAM module. To modify the width or depth, modify the listed parameters in the code. The code assumes that you want to use posedge clk and negedge reset. Modify the always blocks if that is not the case.

VHDL

```
-- Behavioral description of dual-port SRAM with :
--   Active High write enable (WE)
--   Active High read enable (RE)
--   Rising clock edge (Clock)

library ieee;
use ieee.std_logic_1164.all;
use IEEE.std_logic_arith.all;
use IEEE.std_logic_unsigned.all;

entity reg_dpram is
  generic (width      : integer:=8;
          depth       : integer:=8;
          addr        : integer:=3);
  port (Data      : in std_logic_vector (width-1 downto 0);
        Q         : out std_logic_vector (width-1 downto 0);
        Clock     : in std_logic;
        WE        : in std_logic;
        RE        : in std_logic;
        WAddress  : in std_logic_vector (addr-1 downto 0);
        RAddress  : in std_logic_vector (addr-1 downto 0));
end reg_dpram;

architecture behav of reg_dpram is
  type MEM is array (0 to depth-1) of std_logic_vector(width-1
  downto 0);
  signal ramTmp : MEM;
begin

  -- Write Functional Section

  process (Clock)
  begin
    if (clock'event and clock='1') then
      if (WE = '1') then
        ramTmp (conv_integer (WAddress)) <= Data;
      end if;
    end if;
  end process;

  -- Read Functional Section

  process (Clock)
```

```

begin
    if (clock'event and clock='1') then
        if (RE = '1') then
            Q <= ramTmp(conv_integer (RAddress));
        end if;
    end if;
end process;

end behavior;

```

Verilog

```

`timescale 1 ns/100 ps
//#####
//# Behavioral dual-port SRAM description :
//#   Active High write enable (WE)
//#   Active High read enable (RE)
//#   Rising clock edge (Clock)
//#####

module reg_dpram (Data, Q, Clock, WE, RE, WAddress, RAddress);

parameter width = 8;
parameter depth = 8;
parameter addr = 3;

input Clock, WE, RE;
input [addr-1:0] WAddress, RAddress;
input [width-1:0] Data;
output [width-1:0] Q;
reg [width-1:0] Q;
reg [width-1:0] mem_data [depth-1:0];

// #####
// # Write Functional Section
// #####
always @(posedge Clock)
begin
    if(WE)
        mem_data[WAddress] = #1 Data;
end

//#####
//# Read Functional Section
//#####
always @(posedge Clock)
begin
    if(RE)
        Q = #1 mem_data[RAddress];
end

endmodule

```

ACTgen RAM

The RAM cells in the 3200DX and 42 MX families of devices support asynchronous and synchronous dual-port RAM. The basic RAM cells can be configured as 32x8 or 64x4. However, most synthesis tools cannot infer technology specific features such as RAM cells. The following example shows an ACTgen structural implementation for instantiation. Although the behavioral description is synthesizable, the implementation is not optimal for speed and area.

Using ACTgen, generate a 32x16 dual port RAM with the configuration shown in the figure below. Save the structured Verilog or VHDL implementations as “ram”.

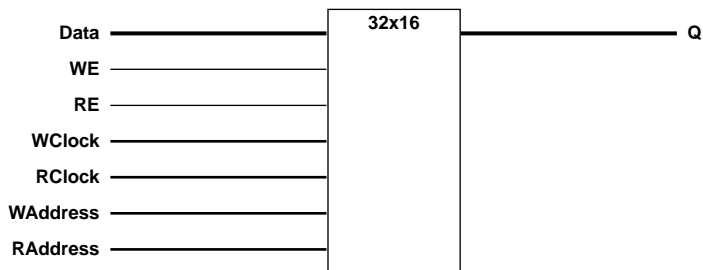

VHDL

```
library IEEE;
use IEEE.std_logic_1164.all;
use IEEE.std_logic_unsigned.all;

entity ram32_16 is
    port (WAddress, RAddress:in std_logic_vector(4 downto 0);
          Data : in std_logic_vector (15 downto 0);
          Aclr, WClock, RClock,WE,RE:in std_logic;
          Q :out std_logic_vector (15 downto 0));
end ram32_16;

architecture rtl of ram32_16 is

component ram
    port (Data      : in std_logic_vector (15 downto 0);
          Aclr      : in std_logic;
          WE        : in std_logic ;
          RE        : in std_logic ;
          WClock    : in std_logic ;
          RClock    : in std_logic ;
          WAddress  : in std_logic_vector (4 downto 0);
          RAddress  : in std_logic_vector (4 downto 0);
          Q         : out std_logic_vector (15 downto 0));
```

```

end component;

begin

R_32_16: ram
    port map (Data => Data,
              Aclr => Aclr,
              WE => WE,
              WAddress => WAddress,
              RE => RE,
              RAddress => RAddress,
              WClock => WClock,
              RClock => RClock,
              Q => Q);

end rtl;

```

Verilog

```

module ram (WAddress, RAddress, Data, WClock, WE,
           RE, Rclock, Q);
    input [4:0] WAddress, RAddress;
    input [15:0] Data;
    input Rclock, WClock;
    input WE, RE;
    output [15:0] Q;

    ram R_32_16 (.Data(Data), .WE(WE), .RE(RE), .WClock(WClock),
               .Rclock(Rclock), .Q(Q), .WAddress(WAddress),
               .RAddress(RAddress));

endmodule

```

FIFO

The following example shows how to create a register-based FIFO for non-SRAM based Actel devices.

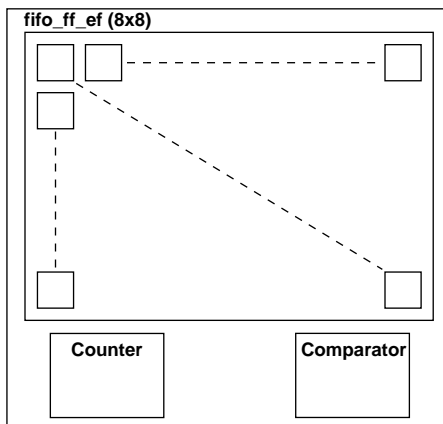

Figure 4-7. FIFO Behavioral Simulation Mode

Register-Based FIFO

The following example show the behavioral model for an 8x 8 FIFO. This code was designed to imitate the behavior of the Actel DX family dual-port SRAM based FIFO and to be synthesizable to a register-based FIFO. To modify the width or depth, simply modify the listed parameters in the code. However, the code does assume that you want to use posedge clk and negedge reset. Modify the always blocks if that is not the case.

VHDL

```
-- *****
-- Behavioral description of dual-port FIFO with :
--   Active High write enable (WE)
--   Active High read enable (RE)
--   Active Low asynchronous clear (Aclr)
--   Rising clock edge (Clock)
--   Active High Full Flag
--   Active Low Empty Flag
-- *****
```



```

library ieee;
use ieee.std_logic_1164.all;
use IEEE.std_logic_arith.all;

entity reg_fifo is

generic (width   : integer:=8;
          depth   : integer:=8;
          addr    : integer:=3);

port (Data      : in std_logic_vector (width-1 downto 0);
       Q         : out std_logic_vector (width-1 downto 0);
       Aclr      : in std_logic;
       Clock     : in std_logic;
       WE        : in std_logic;
       RE        : in std_logic;
       FF        : out std_logic;
       EF        : out std_logic);

end reg_fifo;

library ieee;
use ieee.std_logic_1164.all;
use IEEE.std_logic_arith.all;
use IEEE.std_logic_unsigned.all;

architecture behavioral of reg_fifo is

    type MEM is array(0 to depth-1) of std_logic_vector(width-1 downto
0);
    signal ramTmp      : MEM;
    signal WAddress    : std_logic_vector (addr-1 downto 0);
    signal RAddress    : std_logic_vector (addr-1 downto 0);
    signal words       : std_logic_vector (addr-1 downto 0);

begin

    -- #####
    -- # Write Functional Section
    -- #####

    WRITE_POINTER : process (Aclr, Clock)
    begin
        if (Aclr = '0') then
            WAddress <= (others => '0');
        elsif (Clock'event and Clock = '1') then
            if (WE = '1') then
                if (WAddress = words) then

```

```
        WAddress <= (others => '0');
    else
        WAddress <= WAddress + '1';

    end if;
end if;
end process;

WRITE_RAM : process (Clock)
begin
if (Clock'event and Clock = '1') then
    if (WE = '1') then
        ramTmp (conv_integer (WAddress)) <= Data;
    end if;
end if;
end process;

-- #####
-- # Read Functional Section
-- #####

READ_POINTER : process (Aclr, Clock)
begin
    if (Aclr = '0') then
        RAddress <= (others => '0');
    elsif (Clock'event and Clock = '1') then
        if (RE = '1') then
            if (RAddress = words) then
                RAddress <= (others => '0');
            else
                RAddress <= RAddress + '1';
            end if;
        end if;
    end if;
end process;

READ_RAM : process (Clock)
begin
    if (Clock'event and Clock = '1') then
        if (RE = '1') then
            Q <= ramTmp(conv_integer(RAddress));
        end if;
    end if;
end process;
```

```

-- #####
-- # Full Flag Functional Section : Active high
-- #####

FFLAG : process (Aclr, Clock)
begin
  if (Aclr = '0') then
    FF <= '0';
  elsif (Clock'event and Clock = '1') then
    if (WE = '1' and RE = '0') then
      if ((WAddress = RAddress-1) or
          ((WAddress = depth-1) and (RAddress = 0))) then
        FF <= '1';
      end if;
    else
      FF <= '0';
    end if;
  end if;
end process;

-- #####
-- # Empty Flag Functional Section : Active low
-- #####

EFLAG : process (Aclr, Clock)
begin
  if (Aclr = '0') then
    EF <= '0';
  elsif (Clock'event and Clock = '1') then
    if (RE = '1' and WE = '0') then
      if ((WAddress = RAddress+1) or
          ((RAddress = depth-1) and (WAddress = 0))) then
        EF <= '0';
      end if;
    else
      EF <= '1';
    end if;
  end if;
end process;

end behavioral;

```

Verilog

```
`timescale 1 ns/100 ps
//#####
//# Behavioral description of FIFO with :
//#   Active High write enable (WE)
//#   Active High read enable (RE)
//#   Active Low asynchronous clear (Aclr)
//#   Rising clock edge (Clock)
//#   Active High Full Flag
//#   Active Low Empty Flag
//#####

module reg_fifo (Data, Q, Aclr, Clock, WE, RE, FF, EF);

parameter width = 8;
parameter depth = 8;
parameter addr = 3;

input Clock, WE, RE, Aclr;
input [width-1:0] Data;
output FF, EF;//Full & Empty Flags
output [width-1:0] Q;
reg [width-1:0] Q;
reg [width-1:0] mem_data [depth-1:0];
reg [addr-1:0] WAddress, RAddress;
reg FF, EF;

// #####
// # Write Functional Section
// #####
// WRITE_ADDR_POINTER
always @ (posedge Clock or negedge Aclr)
begin
    if(!Aclr)
        WAddress = #2 0;
    else if (WE)
        WAddress = #2 WAddress + 1;
end

// WRITE_REG
always @ (posedge Clock)
begin
    if(WE)
        mem_data[WAddress] = Data;
end

end
```

```

#####
//# Read Functional Section
#####
// READ_ADDR_POINTER
always @ (posedge Clock or negedge Aclr)
begin
    if(!Aclr)
        RAddress = #1 0;
    else if (RE)
        RAddress = #1 RAddress + 1;
end

// READ_REG
always @ (posedge Clock)
begin
    if (RE)
        Q = mem_data[RAddress];
end

#####
//# Full Flag Functional Section : Active high
#####
always @ (posedge Clock or negedge Aclr)
begin
    if(!Aclr)
        FF = #1 1'b0;
    else if ((WE & !RE) && ((WAddress == RAddress-1) ||
        ((WAddress == depth-1) && (RAddress == 1'b0))))
        FF = #1 1'b1;
    else
        FF = #1 1'b0;
end

#####
//# Empty Flag Functional Section : Active low
#####
always @ (posedge Clock or negedge Aclr)
begin
    if(!Aclr)
        EF = #1 1'b0;
    else if ((!WE & RE) && ((WAddress == RAddress+1) ||
        ((RAddress == depth-1) && (WAddress == 1'b0))))
        EF = #1 1'b0;
    else
        EF = #1 1'b1;
end

endmodule

```

ACTgen FIFO

The RAM cells in the 3200DX and 42MX families of devices can be used to implement a variety of FIFOs. The behavioral description of a 32x8 FIFO for simulation is shown below. However, most synthesis tools cannot infer technology specific features such as RAM cells. Synthesizing this model will result in high area utilization. ACTgen can generate an area and performance optimized structured HDL netlist for instantiation.

Using ACTgen, generate a 32x8 FIFO with the configuration shown in the figure below. Save it as a Verilog or VHDL netlist called “fifo_ff_ef.”

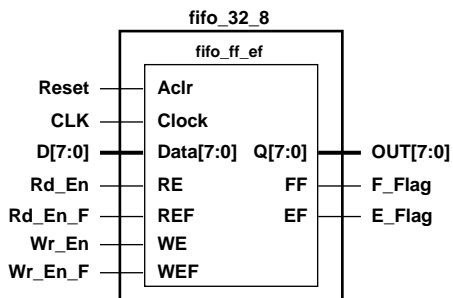

VHDL

```

library IEEE;
use IEEE.std_logic_1164.all;

entity fifo_32_8 is

port (D
      : in std_logic_vector(7 downto 0);
      OUT
      : out std_logic_vector(7 downto 0);
      Reset
      : in std_logic;
      Rd_En, Wr_En
      : in std_logic;
      Rd_En_F, Wr_En_F
      : in std_logic;
      clk
      : in std_logic;
      E_Flag, F_Flag
      : out std_logic);

end fifo_32_8;

architecture fifo_arch of fifo_32_8 is

component fifo_ff_ef
generic (width : integer;
        depth  : integer;
        clrPola : integer;
        clkEdge : integer);

port (Data : in std_logic_vector (width-1 downto 0);
      Aclr  : in std_logic);

```

```

        WE      : in std_logic ;
        WEF     : in std_logic ;
        RE      : in std_logic ;
        REF     : in std_logic ;
        Clock   : in std_logic ;
        Q       : out std_logic_vector (width-1 downto 0);
        FF      : out std_logic;
        EF      : out std_logic);

    end component;

begin

F_32_8: fifo_ff_ef
    generic map (width => 8, depth => 32, clrPola => 1,
                clkEdge => 1)
    port map (Data => D,
              Aclr => Reset,
              WE => We_En,
              WEF => We_En_F,
              RE => Rd_En,
              REF => Rd_En_F,
              Clock => CLK,
              Q => OUT,
              FF => F_Flag,
              EF => E_Flag);

end fifo_arch;

```

Verilog

```

module fifo_32_8 (D, OUT, Reset, Rd_En, Wr_En, CLK, E_Flag,
                 Rd_En_F, Wr_En_F, F_Flag);
    input        [7:0] D;
    output       [7:0] OUT;
    input        Reset;
    input        Rd_En;
    input        Rd_En_F;
    input        Wr_En;
    input        Wr_En_F;
    input        CLK;
    output       E_Flag;
    output       F_Flag;
    wire        [7:0] OUT;
    wire        E_Flag;
    wire        F_Flag;

    fifo_ff_ef F_32_8 (.Data(D), .Aclr(Reset), .WE(Wr_En),
                      .WEF(Wr_En_F), .RE(Rd_En), .REF(Rd_En_F)
                      .Clock(CLK), .Q(OUT), .FF(F_Flag), .EF(E_Flag));

endmodule

```

Product Support

Actel backs its products with various support services including Customer Service, a Customer Applications Center, a Web and FTP site, electronic mail, and worldwide sales offices. This appendix contains information about using these services and contacting Actel for service and support.

Actel U.S. Toll-Free Line

Use the Actel toll-free line to contact Actel for sales information, technical support, requests for literature about Actel and Actel products, Customer Service, investor information, and using the Action Facts service.

The Actel Toll-Free Line is (888) 99-ACTEL.

Customer Service

Contact Customer Service for non-technical product support, such as product pricing, product upgrades, update information, order status, and authorization.

From Northeast and North Central U.S.A., call (408) 522-4480.

From Southeast and Southwest U.S.A., call (408) 522-4480.

From South Central U.S.A., call (408) 522-4434.

From Northwest U.S.A., call (408) 522-4434.

From Canada, call (408) 522-4480.

From Europe, call (408) 522-4252 or +44 (0) 1256 305600.

From Japan, call (408) 522-4743.

From the rest of the world, call (408) 522-4743.

Fax, from anywhere in the world (408) 522-8044.

Customer Applications Center

The Customer Applications Center is staffed by applications engineers who can answer your hardware, software, and design questions.

All calls are answered by our Technical Message Center. The center retrieves information, such as your name, company name, phone number and your question, and then issues a case number. The Center then forwards the information to a queue where the first available application engineer receives the data and returns your call. The phone hours are from 7:30 a.m. to 5 p.m., Pacific Standard Time, Monday through Friday.

The Customer Applications Center number is (800) 262-1060.

European customers can call +44 (0) 1256 305600.

Guru Automated Technical Support

Guru is a Web based automated technical support system accessible through the Actel home page (<http://www.actel.com/guru/>). Guru provides answers to technical questions about Actel products. Many answers include diagrams, illustrations and links to other resources on the Actel Web site. Guru is available 24 hours a day, seven days a week.

Web Site

Actel has a World Wide Web home page where you can browse a variety of technical and non-technical information. Use a Net browser (Netscape recommended) to access Actel's home page.

The URL is <http://www.actel.com>. You are welcome to share the resources we have provided on the net.

Be sure to visit the "Actel User Area" on our Web site, which contains information regarding: products, technical services, current manuals, and release notes.

FTP Site

Actel has an anonymous FTP site located at **ftp://ftp.actel.com**. You can directly obtain library updates, software patches, design files, and data sheets.

Electronic Mail

You can communicate your technical questions to our e-mail address and receive answers back by e-mail, fax, or phone. Also, if you have design problems, you can e-mail your design files to receive assistance. The e-mail account is monitored several times per day.

The technical support e-mail address is **tech@actel.com**.

Worldwide Sales Offices

Headquarters

Actel Corporation
955 East Arques Avenue
Sunnyvale, California 94086
Toll Free: 888.99.ACTEL

Tel: 408.739.1010
Fax: 408.739.1540

US Sales Offices

California

Bay Area
Tel: 408.328.2200
Fax: 408.328.2358

Irvine
Tel: 949.727.0470
Fax: 949.727.0476

San Diego
Tel: 619.938.9860
Fax: 619.938.9887

Thousand Oaks
Tel: 805.375.5769
Fax: 805.375.5749

Colorado

Tel: 303.420.4335
Fax: 303.420.4336

Florida

Tel: 407.677.6661
Fax: 407.677.1030

Georgia

Tel: 770.831.9090
Fax: 770.831.0055

Illinois

Tel: 847.259.1501
Fax: 847.259.1572

Maryland

Tel: 410.381.3289
Fax: 410.290.3291

Massachusetts

Tel: 978.244.3800
Fax: 978.244.3820

Minnesota

Tel: 612.854.8162
Fax: 612.854.8120

North Carolina

Tel: 919.376.5419
Fax: 919.376.5421

Pennsylvania

Tel: 215.830.1458
Fax: 215.706.0680

Texas

Tel: 972.235.8944
Fax: 972.235.965

International Sales Offices

Canada

Suite 203
135 Michael Cowpland Dr,
Kanata, Ontario K2M 2E9

Tel: 613.591.2074
Fax: 613.591.0348

France

361 Avenue General de Gaulle
92147 Clamart Cedex

Tel: +33 (0)1.40.83.11.00
Fax: +33 (0)1.40.94.11.04

Germany

Bahnhofstrasse 15
85375 Neufahrn

Tel: +49 (0)8165.9584.0
Fax: +49 (0)8165.9584.1

Hong Kong

Suite 2206,
Parkside Pacific Place,
88 Queensway

Tel: +011.852.2877.6226
Fax: +011.852.2918.9693

Italy

Via Giovanni da Udine No. 34
20156 Milano

Tel: +39 (0)2.3809.3259
Fax: +39 (0)2.3809.3260

Japan

EXOS Ebisu Building 4F
1-24-14 Ebisu Shibuya-ku
Tokyo 150

Tel: +81 (0)3.3445.7671
Fax: +81 (0)3.3445.7668

Korea

135-090, 18th Floor,
Kyoung AmBldg
157-27 Samsung-dong
Kangnam-ku, Seoul

Tel: +82 (0)2.555.7425
Fax: +82 (0)2.555.5779

Taiwan

4F-3, No. 75, Sec. 1,
Hsin-Tai-Wu Road,
Hsi-chih, Taipei, 221

Tel: +886 (0)2.698.2525
Fax: +886 (0)2.698.2548

United Kingdom

Daneshill House,
Lutyens Close
Basingstoke,
Hampshire RG24 8AG

Tel: +44 (0)1256.305600
Fax: +44 (0)1256.355420

INDEX

A

ACT 3 I/O 73
Actel
 FTP Site 99
 Manuals xiii
 Web Based Technical Support 98
 Web Site 98
ACTgen
 Counter Instantiation 77
 FIFO 94
 RAM 86
Addition 31
Arithmetic Operator 31
 Shift Register Implementation 32
Assumptions x

B

Behavioral Simulation 2
BREPTH 73

C

Capturing a Design 2
Case Statement 21, 63
 Adding Directive 63
CLKBUF 75
CLKINT 75
Coding Dual Architecture 79
 Instantiating 81
 RTL 79
 Structural 80
Combinatorial/Sequential Module Merging 58
Combining Logic 55, 58
Component
 Size 51
 Width 51
Contacting Actel

 Customer Service 97
 Electronic Mail 99
 Technical Support 98
 Toll-Free 97
 Web Based Technical Support 98
Conventions x
 Document x
 Naming, Verilog xii
 Naming, VHDL xi
Counter 27–31
 8-Bit, Count Enable, Asynchronous Reset 28
 8-Bit, Load and Asynchronous Reset 29
 8-Bit, Load, Count Enable, Terminal Count and
 Asynchronous Reset 30
 Instantiation 77
 N-Bit, Load, Count Enable, and Asynchronous
 Reset 30
 Recommendations 27, 77
Critical Path Logic Reduction 53
Customer Service 97

D

Data Shift 35
Datapath 19–36
 Arithmetic Operator 31
 Counter 27
 Decoder 26
 Equality Operator 34
 If-Then-Else 19
 Multiplexor 21
 Relational Operator 33
 Shift Operator 35
Decoder 26
Design Creation/Verification 2
 Behavioral Simulation 2
 EDIF Netlist Generation 3

- HDL Source Entry 2
- Structural Netlist Generation 3
- Structural Simulation 3
- Synthesis 2
- Design Flow
 - Design Creation/Verification 2
 - Design Implementation 3
 - Programming 4
 - System Verification 4
- Design Implementation 3
 - Place and Route 3
 - Timing Analysis 3
 - Timing Simulation 4
- Design Layout 3
- Design Partitioning 62
- Design Synthesis 2
- Designer
 - DT Analyze Tool 3
 - Place and Route 3
 - Timing Analysis 3
- Device Programming 4
- DFPC Cell 73
- Division 31
- D-Latch 5–17
 - with Asynchronous Reset 16
 - with Data and Enable 13
 - with Gated Asynchronous Data 14
 - with Gated Enable 15
- Document
 - Assumptions x
 - Conventions x
 - Organization ix
- Document Conventions x
- Don't Care 25
- DT Analyze 3
- Dual Architecture Coding 79

- Instantiating 81
 - RTL 79
 - Structural 80
- Dual Port SRAM 84, 86
- Duplicating Logic 59

E

- Edge-Triggered Memory Device 5
- EDIF Netlist Generation 3
- Electronic Mail 99
- Equality Operator 34

F

- Fanout
 - High Fanout Networks 75, 77
 - Reducing 59
- FIFO 88–95
 - ACTgen Implementation 94
 - Behavioral Implementation 88
 - Register-Based 88
 - Structural Implementation 94
- Finite State Machine 36–46
 - Combinational Next State Logic 37
 - Combinational Output Logic 37
 - Mealy 39
 - Moore 43
 - One Hot 38
 - Sequential Current State Register 37
 - Structure 37
- Flip-Flop 5–13
 - See Also* Register
 - Positive Edge Triggered 6
 - with Asynchronous Preset 8
 - with Asynchronous Reset 7
 - with Asynchronous Reset and Clock Enable 12
 - with Asynchronous Reset and Preset 9

with Synchronous Preset 11
with Synchronous Reset 10
FSM. *See* Finite State Machine

G

Gate-Level Netlist 2
Generating
 EDIF Netlist 3
 Gate-Level Netlist 2
 Structural Netlist 3
Generics 51–52
Greater Than 33
Greater Than Equal To 33

H

HDL Design Flow
 Design Creation/Verification 2
 Design Implementation 3
 Programming 4
 System Verification 4
HDL Source Entry 2

I

If-Then-Else Statement 19
Input-Output Buffer 46–51
 Bi-Directional 49
 Tri-State 47
Instantiating
 CLKBUF Driver 75
 CLKINT Driver 75
 Counters 77
 Dual Coding 79
 FIFO 94
 QCLKBUF Driver 77
 QCLKINT Driver 77
 RAM 86

Registered I/Os 73
Internal Tri-State Mapping 64
Internally Generated Clock 75, 77

K

Keywords
 Verilog xii
 VHDL xi

L

Latch 5
 Master 73
 Slave 73
Less Than 33
Less Than Equal To 33
Level-Sensitive Memory Device 5
Load Reduction 59
Logic Level Reduction 53
Loops 57

M

Merging Logic Modules 58
Module Block Partitioning 62
Multiplexor 21, 63
 Case X 25
 Four to One 22
 Mapping Internal Tri-State to 64
 Moving Operators Outside Loops 57
 Twelve to One 23
Multiplication 31

N

Naming Conventions
 Verilog xii
 VHDL xi
Netlist Generation

- EDIF 3
- Gate-Level 2
- Structural 3

O

- One Hot State Machine 38
- On-Line Help xvi
- Operators 17
 - Arithmetic 31
 - Equality 34
 - Inside Loops 57
 - Relational 33
 - Removing from Loops 57
 - Shift 35
 - Table of 17

P

- Parallel
 - Encoding 21
 - Operation 63
- Parameters 51–52
- Partitioning a Design 62
- Performance Driven Coding 53–62
- Place and Route 3
- Priority Encoding 19
- Product Support 97–100
 - Customer Applications Center 98
 - Customer Service 97
 - Electronic Mail 99
 - FTP Site 99
 - Technical Support 98
 - Toll-Free Line 97
 - Web Site 98
- Programming a Device 4

Q

- QCLKBUF 77
- QCLKINT 77
- Quadrant Clock 77
 - Limitations 77

R

- RAM 86
- Reducing Fanout 59
- Reducing Logic
 - on a Critical Path 53
 - Usage 55
- Register 66
 - See Also* Flip-Flop
 - Asynchronous Preset 70
 - Asynchronous Preset and Clear 73
 - Clock Enabled 68
 - Duplication 59
 - Functionally Equivalent Asynchronous Preset 70
 - Placed at Hierarchical Boundaries 62
 - Recommended Usage 66–73
 - Synchronous Clear or Preset 67
- Register-Based
 - FIFO 88
 - SRAM 82–85
 - Dual Port 84
 - Single Port 82
- Registered I/O 73
 - BREPTH 73
- Related Manuals xiii, xv
- Relational Operator 33
- Removing Operators from Loops 57
- Reset Signals 75, 77
- Resource Sharing 55

S

- Sequential Device 5–13
 - D-Latch 5
 - Flip-Flop 5
- Sharing Resources 55
- Shift
 - Operator 35
 - Register 32
- Simulation
 - Behavioral 2
 - Structural 3
 - Timing 4
- Single Port SRAM 82
- Size 51
- SRAM 82–87
 - ACTgen Implementation 86
 - Dual Port 84
 - Register Based 82
 - Single Port 82
 - Structural Implementation 86
- Static Timing Analysis 3
- Structural Netlist Generation 3
- Structural Simulation 3
- Subtraction 31
- Synthesis 2
 - Reducing Duration of 62
- System Verification, Silicon Explorer 4

T

- Technical Support 98
- Technology Independent Coding 5–52
- Technology Specific Coding 63–95
- Timing
 - Analysis 3
 - Constraints 53
 - Simulation 4

- Toll-Free Line 97
- Tri-State Mapping 64
- True/False Operands 34

U

- Unit Delays 2

V

- Verilog
 - Naming Conventions xii
 - Reserved Words xii
- VHDL
 - Naming Conventions xi
 - Reserved Words xi

W

- Web Based Technical Support 98
- Width 51

