

Actel® HDL Coding

Style Guide

Actel Corporation, Sunnyvale, CA 94086

© 2001 Actel Corporation. All rights reserved.

Printed in the United States of America

Part Number: 5029105-6

Release: June 2002

No part of this document may be copied or reproduced in any form or by any means without prior written consent of Actel.

Actel makes no warranties with respect to this documentation and disclaims any implied warranties of merchantability or fitness for a particular purpose.

Information in this document is subject to change without notice. Actel assumes no responsibility for any errors that may appear in this document.

This document contains confidential proprietary information that is not to be disclosed to any unauthorized person without prior written consent of Actel Corporation.

Trademarks

Actel and the Actel logotype are registered trademarks of Actel Corporation.

Verilog is a registered trademark of Open Verilog International.

All other products or brand names mentioned are trademarks or registered trademarks of their respective holders.

Table of Contents

Introduction	ix
Document Organization	ix
Document Assumptionsx
Document Conventionsx
HDL Keywords and Naming Conventions	xi
VHDL	xi
Verilog	xii
Your Comments	xiii
Actel Manuals	xiii
Related Manuals	xvi
Online Help	xvi
1 Design Flow	1
Design Flow Illustrated	1
Design Flow Overview	2
Design Creation/Verification	2
Design Implementation	3
Programming	4
System Verification	4
2 Technology Independent Coding Styles	5
Sequential Devices	5
Flip-Flops (Registers)	5
D-Latches	13
Operators	17
Datapath	19
Priority Encoders Using If-Then-Else	19
Multiplexors Using Case	21
Decoders	26
Counters	27
Arithmetic Operators	31
Relational Operators	33

Equality Operator	34
Shift Operators	35
Finite State Machine	36
Mealy Machine	39
Moore Machine	43
Input-Output Buffers	46
Tri-State Buffer	47
Bi-Directional Buffer	49
Generics and Parameters.	51
3 Performance Driven Coding	53
Reducing Logic Levels on Critical Paths	53
Example 1	53
Example 2	54
Resource Sharing	56
Example 1	56
Example 2	56
Operators Inside Loops	58
Coding for Combinability	59
Register Duplication	61
Partitioning a Design	63
Registers Embedded Within a Module	63
Registers Pushed Out at the Hierarchical Boundary.	64
4 Technology Specific Coding Techniques	65
Multiplexors.	65
Internal Tri-State to Multiplexor Mapping	65
Registers	68
Synchronous Clear or Preset	69
Clock Enabled	70
Asynchronous Preset	72
Asynchronous Preset and Clear	75

Registered I/Os	75
CLKINT/CLKBUF for Reset and/or High Fanout Networks	77
QCLKINT/QCLKBUF for Medium Fanout Networks	79
ACTgen Counter.	79
Dual Architecture Coding in VHDL	81
RTL Architecture	81
Structural Architecture	82
Instantiating “CNT5” in the Top Level Design	83
SRAM	84
Register-Based Single Port SRAM	84
Register-Based Dual-Port SRAM	86
ACTgen RAM	88
FIFO	90
Register-Based FIFO	90
ACTgen FIFO	96
A Product Support	99
Actel U.S. Toll-Free Line	99
Customer Service	99
Customer Applications Center	100
Guru Automated Technical Support	100
Web Site	100
FTP Site.	101
Contacting the Customer Applications Center	101
Electronic Mail	101
Telephone	101
Worldwide Sales Offices	102
Headquarters.	102
INDEX.	103

Introduction

VHDL and Verilog[®] HDL are high level description languages for system and circuit design. These languages support various abstraction levels of design, including architecture-specific design. At the higher levels, these languages can be used for system design without regard to a specific technology. To create a functional design, you only need to consider a specific target technology. However, to achieve optimal performance and area from your target device, you must become familiar with the architecture of the device and then code your design for that architecture.

Efficient, standard HDL code is essential for creating good designs. The structure of the design is a direct result of the structure of the HDL code. Additionally, standard HDL code allows designs to be reused in other designs or by other HDL designers.

This document provides the preferred coding styles for the Actel architecture. The information is reference material with instructions to optimize your HDL code for the Actel architecture. Examples in both VHDL and Verilog code are provided to illustrate these coding styles and to help implement the code into your design.

For further information about HDL coding styles, synthesis methodology, or application notes, please visit Actel's web site at the following URL: <http://www.actel.com/>

Document Organization

The *Actel HDL Coding Style Guide* is divided into the following chapters:

Chapter 1 - Design Flow describes the basic design flow for creating Actel designs with HDL synthesis and simulation tools.

Chapter 2 - Technology Independent Coding Styles describes basic high level HDL coding styles and techniques.

Chapter 3 - Performance Driven Coding illustrates efficient design practices and describes synthesis implementations and techniques that can be used to reduce logic levels on a critical path.

Chapter 4 - Technology Specific Coding Techniques describes how to implement technology specific features and technology specific macros for optimal area and performance utilization.

Appendix A - Product Support provides information about contacting Actel for customer and technical support.

Document Assumptions

The information in this manual is based on the following assumptions:

- You are familiar with Verilog or VHDL hardware description language, and HDL design methodology for designing logic circuits.
- You are familiar with FPGA design software, including design synthesis and simulation tools.

Document Conventions

The following conventions are used throughout this manual.

Information input by the user follows this format:

keyboard input

The contents of a file follows this format:

file contents

HDL code appear as follows, with HDL keyword in bold:

```
entity actel is  
port (  
    a: in bit;  
    y: out bit);  
end actel;
```

Messages that are displayed on the screen appear as follows:

Screen Message

HDL Keywords and Naming Conventions

There are naming conventions you must follow when writing Verilog or VHDL code. Additionally, Verilog and VHDL have reserved words that cannot be used for signal or entity names. This section lists the naming conventions and reserved keywords for each.

VHDL

The following naming conventions apply to VHDL designs:

- VHDL is not case sensitive.
- Two dashes “--” are used to begin comment lines.
- Names can use alphanumeric characters and the underscore “_” character.
- Names must begin with an alphabetic letter.
- You may not use two underscores in a row, or use an underscore as the last character in the name.
- Spaces are not allowed within names.
- Object names must be unique. For example, you cannot have a signal named A and a bus named A(7 **downto** 0).

The following is a list of the VHDL reserved keywords:

abs	downto	library	postponed	subtype
access	else	linkage	procedure	then
after	elsif	literal	process	to
alias	end	loop	pure	transport
all	entity	map	range	type
and	exit	mod	record	unaffected
architecture	file	nand	register	units
array	for	new	reject	until
assert	function	next	rem	use
attribute	generate	nor	report	variable
begin	generic	not	return	wait
block	group	null	rol	when

body	guarded	of	ror	while
buffer	if	on	select	with
bus	impure	open	severity	xnor
case	in	or	shared	xor
component	inertial	others	signal	
configuration	inout	out	sla	
constant	is	package	sra	
disconnect	label	port	srl	

Verilog

The following naming conventions apply to Verilog HDL designs:

- Verilog is case sensitive.
- Two slashes “//” are used to begin single line comments. A slash and asterisk “/*” are used to begin a multiple line comment and an asterisk and slash “*/” are used to end a multiple line comment.
- Names can use alphanumeric characters, the underscore “_” character, and the dollar “\$” character.
- Names must begin with an alphabetic letter or the underscore.
- Spaces are not allowed within names.

The following is a list of the Verilog reserved keywords:

always	endmodule	medium	reg	tranif0
and	endprimitive	module	release	tranif1
assign	endspecify	nand	repeat	tri
attribute	endtable	negedge	rnmos	tri0
begin	endtask	nmos	rpmos	tri1
buf	event	nor	rtran	triand
bufif0	for	not	rtranif0	trior
bufif1	force	notif0	rtranif1	trireg
case	forever	notif1	scalared	unsigned
casex	fork	or	signed	vectored
casez	function	output	small	wait
cmos	highz0	parameter	specify	wand

deassign	highz1	pmos	specparam	weak0
default	if	posedge	strength	weak1
defparam	ifnone	primitive	strong0	while
disable	initial	pull0	strong1	wire
edge	inout	pull1	supply0	wor
else	input	pulldown	supply1	xnor
end	integer	pullup	table	xor
endattribute	join	remos	task	
endcase	large	real	time	
endfunction	macromodule	realtime	tran	

Your Comments

Actel Corporation strives to produce the highest quality online help and printed documentation. We want to help you learn about our products, so you can get your work done quickly. We welcome your feedback about this guide and our online help. Please send your comments to **documentation@actel.com**.

Actel Manuals

Designer and Libero include printed and online manuals. The online manuals are in PDF format and available from Libero and Designer's Start Menus and on the CD-ROM. From the Start menu choose:

- Programs > Libero 2.2 > Libero 2.2 Documentation.
- Programs > Designer Series > R1-2002 Documentation

Also, the online manuals are in PDF format on the CD-ROM in the “/manuals” directory. These manuals are also installed onto your system when you install the Designer software. To view the online manuals, you must install Adobe® Acrobat Reader® from the CD-ROM.

The Designer Series includes the following manuals, which provide additional information on designing Actel FPGAs:

Getting Started User's Guide. This manual contains information for using the Designer Series Development System software to create designs for, and program, Actel devices.

Designer User's Guide. This manual provides an introduction to the Designer series software as well as an explanation of its tools and features.

PinEdit User's Guide. This guide provides a detailed description of the PinEdit tool in Designer. It includes cross-platform explanations of all the PinEdit features.

ChipEdit User's Guide. This guide provides a detailed description of the ChipEdit tool in Designer. It includes a detailed explanation of the ChipEdit functionality.

Timer User's Guide. This guide provides a detailed description of the Timer tool in Designer. It includes a detailed explanation of the Timer functionality.

SmartPower User's Guide. This guide provides a detailed description of using the SmartPower tool to perform power analysis.

Netlist Viewer User's Guide. This guide provides a detailed description of the Netlist Viewer. Information on using the Netlist Viewer with Timer and ChipEdit to debug your netlist is provided.

A Guide to ACTgen Macros. This Guide provides descriptions of macros that can be generated using the Actel ACTgen Macro Builder software.

Actel HDL Coding Style Guide. This guide provides preferred coding styles for the Actel architecture and information about optimizing your HDL code for Actel devices.

Silicon Expert User's Guide. This guide contains information to assist designers in the use of Actel's Silicon Expert tool.

Cadence[®] Interface Guide. This guide contains information to assist designers in the design of Actel devices using Cadence CAE software and the Designer Series software.

Mentor Graphics[®] Interface Guide. This guide contains information to assist designers in the design of Actel devices using Mentor Graphics CAE software and the Designer Series software.

Synopsys[®] Synthesis Methodology Guide. This guide contains preferred HDL coding styles and information to assist designers in the design of Actel devices using Synopsys CAE software and the Designer Series software.

Innoveda[®] eProduct Designer Interface Guide (Windows). This guide contains information to assist designers in the design of Actel devices using eProduct Designer CAE software and the Designer Series software.

VHDL Vital Simulation Guide. This guide contains information to assist designers in simulating Actel designs using a Vital compliant VHDL simulator.

Verilog Simulation Guide. This guide contains information to assist designers in simulating Actel designs using a Verilog simulator.

Activator and APS Programming System

Installation and User's Guide. This guide contains information about how to program and debug Actel devices, including information about using the Silicon Explorer diagnostic tool for system verification.

Silicon Sculptor User's Guide. This guide contains information about how to program Actel devices using the Silicon Sculptor software and device programmer.

Flash Pro User's Guide. This guide contains information about how to program Actel ProASIC and ProASIC^{PLUS} devices using the Flash Pro software and device programmer.

Silicon Explorer II. This guide contains information about connecting the Silicon Explorer diagnostic tool and using it to perform system verification.

Macro Library Guide. This guide provides descriptions of Actel library elements for Actel device families. Symbols, truth tables, and module count are included for all macros.

ProASIC^{PLUS} Macro Library Guide. This guide provides descriptions of Actel library elements for Actel ProASIC and ProASIC^{PLUS} device families. Symbols, truth tables, and tile usage are included for all macros.

Related Manuals

The following manuals provide additional information about designing and programming Actel FPGAs using HDL design methodology:

Digital Design and Synthesis with Verilog HDL. Madhavan, Rajeev, and others. San Jose, CA: Automata Publishing Company, 1993. This book contains information to allow designers to write synthesizable designs with Verilog HDL.

HDL Chip Design. Smith, Douglas J. Madison, AL: Doone Publications, 1996. This book describes and gives examples of how to design FPGAs using VHDL and Verilog.

IEEE Standard VHDL Language Reference Manual. New York: Institute of Electrical and Electronics Engineers, Inc., 1994. This manual specifies IEEE Standard 1076-1993, which defines the VHDL standard and the use of VHDL in the creation of electronic systems.

Online Help

The Designer Series software comes with online help. Online help specific to each software tool is available in Libero, Designer, ACTgen, ACTmap, Silicon Expert, Silicon Explorer II, Silicon Sculptor, and APSW.

Design Flow

This chapter illustrates and describes the basic design flow for creating Actel designs using HDL synthesis and simulation tools.

Design Flow Illustrated

Figure 1-1 illustrates the HDL synthesis-based design flow for an Actel FPGA using third party CAE tools and Designer software¹.

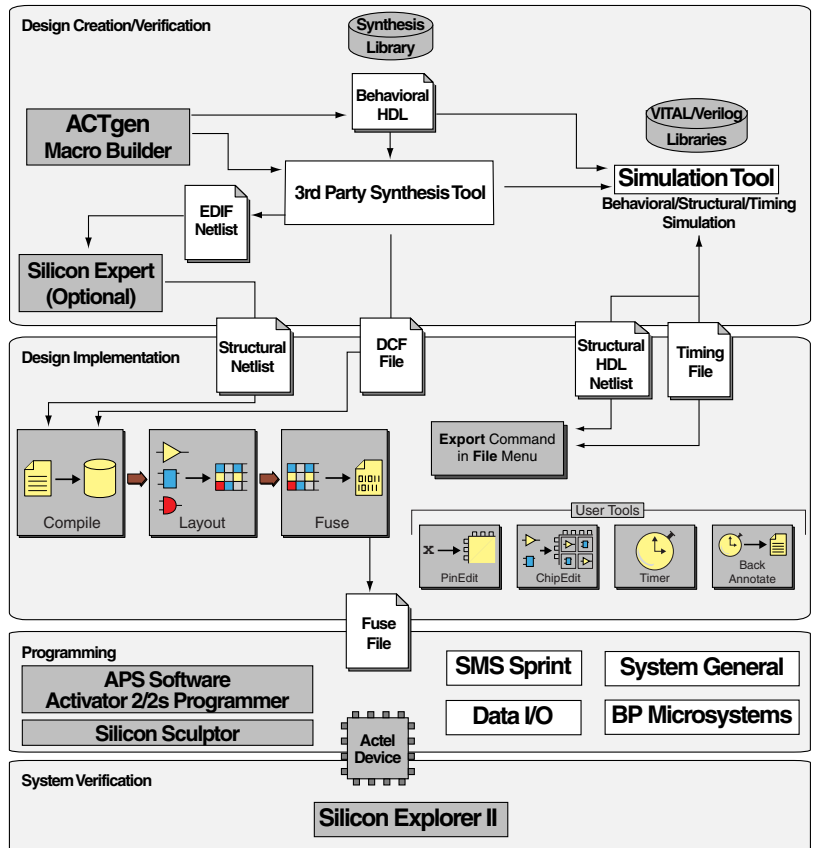

Figure 1-1. Actel HDL Synthesis-Based Design Flow

1. Actel-specific utilities/tools are denoted by grey boxes in Figure 1-1.

Design Flow Overview

The Actel HDL synthesis-based design flow has four main steps: design creation/verification, design implementation, programming, and system verification. These steps are described in detail in the following sections.

Design Creation/ Verification

During design creation/verification, a design is captured in an RTL-level (behavioral) HDL source file. After capturing the design, a behavioral simulation of the HDL file can be performed to verify that the HDL code is correct. The code is then synthesized into an Actel gate-level (structural) HDL netlist. After synthesis, a structural simulation of the design can be performed. Finally, an EDIF netlist is generated for use in Designer and an HDL structural netlist is generated for timing simulation.

HDL Design Source Entry

Enter your HDL design source using a text editor or a context-sensitive HDL editor. Your HDL source file can contain RTL-level constructs, as well as instantiations of structural elements, such as ACTgen macros.

Behavioral Simulation

You can perform a behavioral simulation of your design before synthesis. Behavioral simulation verifies the functionality of your HDL code. Typically, unit delays are used and a standard HDL test bench can be used to drive simulation. Refer to the documentation included with your simulation tool for information about performing behavioral simulation.

Synthesis

After you have created your behavioral HDL source file, you must synthesize it before placing and routing it in Designer. Synthesis translates the behavioral HDL file into a gate-level netlist and optimizes the design for a target technology. Refer to the documentation included with your synthesis tool for information about performing design synthesis.

Netlist Generation

After you have created, synthesized, and verified your design, you may place-and-route in Designer using an EDIF, Verilog, or VHDL netlist. This netlist is also used to generate a structural HDL netlist for use in

structural simulation. Refer to the Designer Series documentation for information about generating a netlist.

Structural Netlist Generation

You can generate a structural HDL netlist from your EDIF netlist for use in structural simulation by either exporting it from Designer or by using the Actel “edn2vhdl” or “edn2vlog” program. Refer to the Designer Series documentation for information about generating a structural netlist.

Structural Simulation

You can perform a structural simulation of your design before placing and routing it. Structural simulation verifies the functionality of your post-synthesis structural HDL netlist. Default unit delays included in the compiled Actel VITAL libraries are used for every gate. Refer to the documentation included with your simulation tool for information about performing structural simulation.

Design Implementation

During design implementation, a design is placed-and-routed using Designer. Additionally, timing analysis is performed on a design in Designer with the Timer tool. After place-and-route, post-layout (timing) simulation is performed.

Place-and-Route

Use Designer to place-and-route your design. Refer to the Designer Series documentation for information about using Designer.

Timing Analysis

Use the Timer tool in Designer to perform static timing analysis on your design. Refer to the *Timer User's Guide* for information about using Timer.

Timing Simulation

After placing-and-routing your design, you perform a timing simulation to verify that the design meets timing constraints. Timing simulation requires timing information exported from Designer, which overrides default unit delays in the compiled Actel VITAL libraries. Refer to the Designer Series documentation for information about exporting timing information from Designer.

Programming

Programming a device requires software and hardware from Actel or a supported 3rd party programming system. Refer to the *Getting Started User's Guide*, the *Using Designer* manual, and the *Activator Installation and APS Programming Guide* for information on programming an Actel device.

System Verification

You can perform system verification on a programmed device using Actel's Silicon Explorer. Refer to the *Activator Installation and APS Programming Guide* or *Silicon Explorer II Quick Start* for information on using Silicon Explorer.

Technology Independent Coding Styles

This chapter describes basic HDL coding styles and techniques. These coding styles are essential when writing efficient, standard HDL code and creating technology independent designs.

Sequential Devices

A sequential device, either a flip-flop or a latch, is a one-bit memory device. A latch is a level-sensitive memory device and a flip-flop is an edge-triggered memory device.

Flip-Flops (Registers)

Flip-flops, also called registers, are inferred in VHDL using wait and if statements within a process using either a rising edge or falling edge detection expression. There are two types of expressions that can be used, a 'event attribute or a function call. For example:

```
(clk'event and clk='1')      --rising edge 'event attribute
(clk'event and clk='0')      --falling edge 'event attribute
rising_edge(clock)           --rising edge function call
falling_edge(clock)          --falling edge function call
```

The examples in this guide use rising edge 'event attribute expressions, but falling edge expressions could be used. The 'event attribute expression is used because some VHDL synthesis tools may not recognize function call expressions. However, using a function call expression is preferred for simulation because a function call only detects an edge transition (0 to 1 or 1 to 0) but not a transition from X to 1 or 0 to X, which may not be a valid transition. This is especially true if using a multi-valued data type like `std_logic`, which has nine possible values (U, X, 0, 1, Z, W, L, H, -).

This section describes and gives examples for different types of flip-flops. Refer to “Registers” on page 68 for additional information about using specific registers in the Actel architecture.

Rising Edge Flip-Flop

The following examples infer a D flip-flop without asynchronous or synchronous reset or preset. This flip-flop is a basic sequential cell in the Actel antifuse architecture.

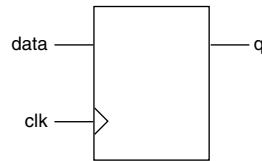

Figure 2-1. D Flip Flop

VHDL

```
library IEEE;
use IEEE.std_logic_1164.all;

entity dff is
port (data, clk : in std_logic;
      q : out std_logic);
end dff;

architecture behav of dff is
begin
process (clk) begin
    if (clk'event and clk = '1') then
        q <= data;
    end if;
end process;
end behav;
```

Verilog

```
module dff (data, clk, q);
    input data, clk;
    output q;
    reg q;
    always @(posedge clk)
        q = data;
endmodule
```

Rising Edge Flip-Flop with Asynchronous Reset

The following examples infer a D flip-flop with an asynchronous reset. This flip-flop is a basic sequential cell in the Actel antifuse architecture.

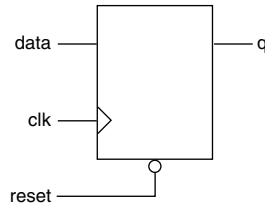

Figure 2-2. D Flip-Flop with Asynchronous Reset

VHDL

```

library IEEE;
use IEEE.std_logic_1164.all;

entity dff_async_rst is
port (data, clk, reset : in std_logic;
      q : out std_logic);
end dff_async_rst;

architecture behav of dff_async_rst is
begin
process (clk, reset) begin
  if (reset = '0') then
    q <= '0';
  elsif (clk'event and clk = '1') then
    q <= data;
  end if;
end process;
end behav;

```

Verilog

```

module dff_async_rst (data, clk, reset, q);
  input data, clk, reset;
  output q;
  reg q;
  always @(posedge clk or negedge reset)
    if (~reset)
      q = 1'b0;
    else
      q = data;
endmodule

```

Rising Edge Flip-Flop with Asynchronous Preset

The following examples infer a D flip-flop with an asynchronous preset. Refer to “Registers” on page 68 for additional information about using preset flip-flops with the Actel architecture.

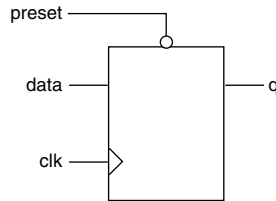

Figure 2-3. D Flip-Flop with Asynchronous Preset

VHDL

```
library IEEE;
use IEEE.std_logic_1164.all;

entity dff_async_pre is
port (data, clk, preset : in std_logic;
      q : out std_logic);
end dff_async_pre;

architecture behav of dff_async_pre is
begin
process (clk, preset) begin
  if (preset = '0') then
    q <= '1';
  elsif (clk'event and clk = '1') then
    q <= data;
  end if;
end process;
end behav;
```

Verilog

```
module dff_async_pre (data, clk, preset, q);
input data, clk, preset;
output q;
reg q;
always @(posedge clk or negedge preset)
  if (~preset)
    q = 1'b1;
  else
    q = data;
endmodule
```

Rising Edge Flip-Flop with Asynchronous Reset and Preset

The following examples infer a D flip-flop with an asynchronous reset and preset. Refer to “Registers” on page 68 for additional information about using preset flip-flops with the Actel architecture.

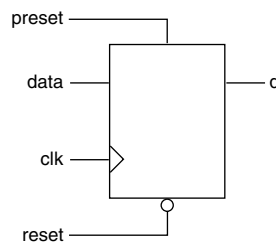

Figure 2-4. DFlip-Flop

VHDL

```

library IEEE;
use IEEE.std_logic_1164.all;

entity dff_async is
port (data, clk, reset, preset : in std_logic;
      q : out std_logic);
end dff_async;

architecture behav of dff_async is
begin
process (clk, reset, preset) begin
  if (reset = '0') then
    q <= '0';
  elsif (preset = '1') then
    q <= '1';
  elsif (clk'event and clk = '1') then
    q <= data;
  end if;
end process;
end behav;

```

Verilog

```

module dff_async (reset, preset, data, q, clk);
  input clk;
  input reset, preset, data;

```

```
output q;  
reg q;  
always @ (posedge clk or negedge reset or posedge preset)  
if (~reset)  
q = 1'b0;  
else if (preset)  
q = 1'b1;  
else q = data;  
endmodule
```

Rising Edge Flip-Flop with Synchronous Reset

The following examples infer a D flip-flop with a synchronous reset.

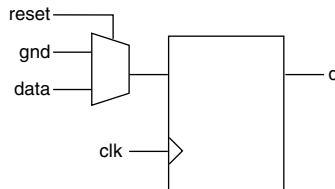

Figure 2-5. D Flip-Flop with Synchronous Reset

VHDL

```
library IEEE;  
use IEEE.std_logic_1164.all;  
  
entity dff_sync_rst is  
port (data, clk, reset : in std_logic;  
q : out std_logic);  
end dff_sync_rst;  
  
architecture behav of dff_sync_rst is  
begin  
process (clk) begin  
if (clk'event and clk = '1') then  
if (reset = '0') then  
q <= '0';  
else q <= data;  
end if;  
end if;  
end process;  
end behav;
```

Verilog

```

module dff_sync_rst (data, clk, reset, q);
    input data, clk, reset;
    output q;
    reg q;
    always @ (posedge clk)
        if (~reset)
            q = 1'b0;
        else q = data;
endmodule

```

Rising Edge Flip-Flop with Synchronous Preset

The following examples infer a D flip-flop with a synchronous preset.

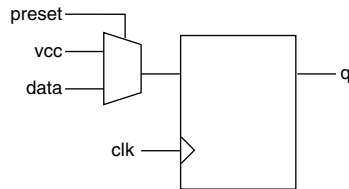

Figure 2-6. D Flip-Flop with Synchronous Preset

VHDL

```

library IEEE;
use IEEE.std_logic_1164.all;

entity dff_sync_pre is
    port (data, clk, preset : in std_logic;
          q : out std_logic);
end dff_sync_pre;

architecture behav of dff_sync_pre is
begin
    process (clk) begin
        if (clk'event and clk = '1') then
            if (preset = '0') then
                q <= '1';
            else q <= data;
            end if;
        end if;
    end process;
end behav;

```

Verilog

```
module dff_sync_pre (data, clk, preset, q);
    input data, clk, preset;
    output q;
    reg q;
    always @ (posedge clk)
        if (~preset)
            q = 1'b1;
        else q = data;
endmodule
```

Rising Edge Flip-Flop with Asynchronous Reset and Clock Enable

The following examples infer a D type flip-flop with an asynchronous reset and clock enable.

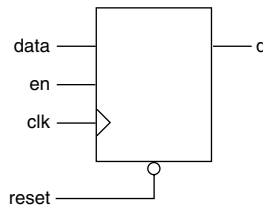

Figure 2-7. D Flip-Flop

VHDL

```
library IEEE;
use IEEE.std_logic_1164.all;

entity dff_ck_en is
    port (data, clk, reset, en : in std_logic;
          q : out std_logic);
end dff_ck_en;

architecture behav of dff_ck_en is
begin
    process (clk, reset) begin
        if (reset = '0') then
            q <= '0';
        elsif (clk'event and clk = '1') then
            if (en = '1') then
                q <= data;
            end if;
        end if;
    end process;
end behav;
```

Verilog

```

module dff_ck_en (data, clk, reset, en, q);
  input data, clk, reset, en;
  output q;
  reg q;
  always @ (posedge clk or negedge reset)
    if (~reset)
      q = 1'b0;
    else if (en)
      q = data;
endmodule

```

D-Latches

This section describes and gives examples of different types of D-latches.

D-Latch with Data and Enable

The following examples infer a D-latch with data and enable inputs.

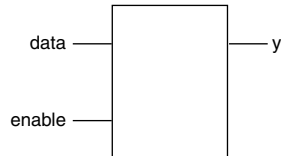

Figure 2-8. D-Latch

VHDL

```

library IEEE;
use IEEE.std_logic_1164.all;

entity d_latch is
  port(enable, data: in std_logic;
        y : out std_logic);
end d_latch;

architecture behave of d_latch is
begin
  process (enable, data)
  begin
    if (enable = '1') then
      y <= data;
    end if;
  end process;
end behave;

```

Verilog

```
module d_latch (enable, data, y);  
    input enable, data;  
    output y;  
    reg y;  
    always @(enable or data)  
        if (enable)  
            y = data;  
endmodule
```

D-Latch with Gated Asynchronous Data

The following examples infer a D-latch with gated asynchronous data.

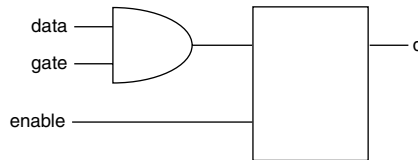

Figure 2-9. D-Latch with Gated Asynchronous Data

VHDL

```
library IEEE;  
use IEEE.std_logic_1164.all;  
  
entity d_latch_e is  
    port (enable, gate, data : in std_logic;  
          q : out std_logic);  
end d_latch_e;  
  
architecture behave of d_latch_e is  
begin  
    process (enable, gate, data) begin  
        if (enable = '1') then  
            q <= data and gate;  
        end if;  
    end process;  
end behave;
```

Verilog

```

module d_latch_e(enable, gate, data, q);
    input enable, gate, data;
    output q;
    reg q;
    always @ (enable or data or gate)
        if (enable)
            q = (data & gate);
endmodule

```

D-Latch with Gated Enable

The following examples infer a D-latch with gated enable.

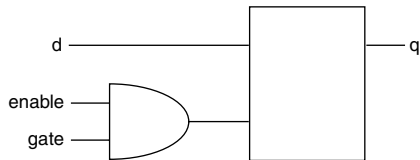

Figure 2-10. D-Latch with Gated Enable

VHDL

```

library IEEE;
use IEEE.std_logic_1164.all;

entity d_latch_en is
    port (enable, gate, d: in std_logic;
          q      : out std_logic);
end d_latch_en;

architecture behave of d_latch_en is
begin
    process (enable, gate, d) begin
        if ((enable and gate) = '1') then
            q <= d;
        end if;
    end process;
end behave;

```

Verilog

```
module d_latch_en(enable, gate, d, q);  
    input enable, gate, d;  
    output q;  
    reg q;  
    always @ (enable or d or gate)  
        if (enable & gate)  
            q = d;  
endmodule
```

D-Latch with Asynchronous Reset

The following examples infer a D-latch with an asynchronous reset.

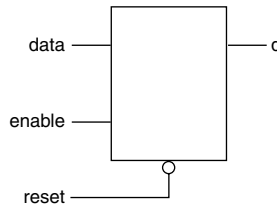

Figure 2-11. D-Latch

VHDL

```
library IEEE;  
use IEEE.std_logic_1164.all;  
  
entity d_latch_rst is  
    port (enable, data, reset: in std_logic;  
          q : out std_logic);  
end d_latch_rst;  
  
architecture behav of d_latch_rst is  
begin  
    process (enable, data, reset) begin  
        if (reset = '0') then  
            q <= '0';  
        elsif (enable = '1') then  
            q <= data;  
        end if;  
    end process;  
end behav;
```

Verilog

```

module d_latch_rst (reset, enable, data, q);
  input reset, enable, data;
  output q;
  reg q;
  always @ (reset or enable or data)
    if (~reset)
      q = 1'b0;
    else if (enable)
      q = data;
endmodule

```

Operators

A number of bit-wise operators are available to you: Arithmetic, Concentration and Replication, Conditional, Equality, Logical Bit-wise, Logical Comparison, Reduction, Relational, Shift, and Unary Arithmetic (Sign). These operators and their availability in VHDL or Verilog are compared in Table 2-1.

Table 2-1. VHDL and Verilog Operators

Operation	Operator	
	VHDL	Verilog
Arithmetic Operators		
exponential	**	
multiplication	*	*
division	/	/
addition	+	+
subtraction	-	-
modulus	mod	%
remainder	rem	
absolute value	abs	
Concentration and Replication Operators		
concentration	&	{ }
replication		{{ }}
Conditional Operator		
conditional		?:

Table 2-1. VHDL and Verilog Operators (Continued)

Operation	Operator	
	VHDL	Verilog
Equality Operators equality inequality	= /=	== !=
Logical Bit-wise Operators unary negation NOT binary AND binary OR binary NAND binary NOR binary XOR binary XNOR	not and or nand nor xor xnor	~ & ^ ^~ or ~^
Logical Comparison Operators NOT AND OR	not and or	! &&
Reduction Operators AND OR NAND NOR XOR XNOR		& ~& ~ ^ ^~ or ~^
Relational Operators less than less than or equal to greater than greater than or equal to	< <= > >=	< <= > >=
Shift Operators logical shift left logical shift right arithmetic shift left arithmetic shift right logical rotate left logical rotate right	sll srl sla sra rol ror	<< >>
Unary Arithmetic Operators identity negotiation	+ -	+ -

Datapath

Datapath logic is a structured repetitive function. These structures are modeled in various different implementations based on area and timing constraints. Most synthesis tools generate optimal implementations for the target technology.

Priority Encoders Using If-Then-Else

An if-then-else statement is used to conditionally execute sequential statements based on a value. Each condition of the if-then-else statement is checked in order against that value until a true condition is found. Statements associated with the true condition are then executed and the rest of the statement is ignored. If-then-else statements should be used to imply priority on a late arriving signal. In the following examples, shown in Figure 2-12, signal *c* is a late arriving signal.

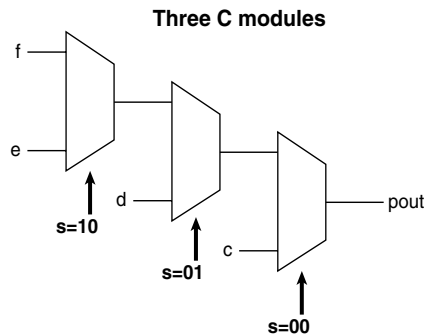

Figure 2-12. Priority Encoder Using an If-Then-Else Statement

VHDL

```

library IEEE;
use IEEE.std_logic_1164.all;

entity my_if is
port (c, d, e, f: in std_logic;
      s      : in std_logic_vector(1 downto 0);
      pout  : out std_logic);
end my_if;

architecture my_arc of my_if is

```

```
begin
myif_pro: process (s, c, d, e, f) begin
    if s = "00" then
        pout <= c;
    elsif s = "01" then
        pout <= d;
    elsif s = "10" then
        pout <= e;
    else pout <= f;
    end if;
end process myif_pro;
end my_arc;
```

Verilog

```
module IF_MUX (c, d, e, f, s, pout);
    input c, d, e, f;
    input [1:0]s;
    output pout;
    reg pout;
always @(c or d or e or f or s) begin
    if (s == 2'b00)
        pout = c;
    else if (s ==2'b01)
        pout = d;
    else if (s ==2'b10)
        pout = e;
    else pout = f;
    end
endmodule
```

Multiplexors Using Case

A case statement implies parallel encoding. Use a case statement to select one of several alternative statement sequences based on the value of a condition. The condition is checked against each choice in the case statement until a match is found. Statements associated with the matching choice are then executed. The case statement must include all possible values for a condition or have a default choice to be executed if none of the choices match. The following examples infer multiplexors using a case statement. Refer to “Multiplexors” on page 65 for additional information about using multiplexors with the Actel architecture.

VHDL synthesis tools automatically assume parallel operation without priority in case statements. However, some Verilog tools assume priority, and you may need to add a directive to your case statement to ensure that no priority is assumed. refer to the documentation provided with your synthesis tool for information about creating case statements without priority.

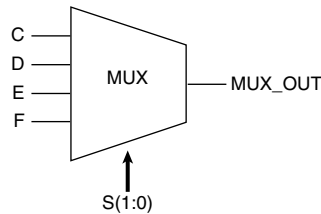

Figure 2-13. Multiplexor Using a Case Statement

4:1 Multiplexor

The following examples infer a 4:1 multiplexor using a case statement.

VHDL

```
--4:1 Multiplexor
library IEEE;
use IEEE.std_logic_1164.all;

entity mux is
port (C, D, E, F : in std_logic;
      S          : in std_logic_vector(1 downto 0);
      mux_out    : out std_logic);
end mux;

architecture my_mux of mux is
begin
mux1: process (S, C, D, E, F) begin
  case s is
    when "00" => muxout <= C;
    when "01" => muxout <= D;
    when "10" => muxout <= E;
    when others => muxout <= F;
  end case;
end process mux1;
end my_mux;
```

Verilog

```
//4:1 Multiplexor
module MUX (C, D, E, F, S, MUX_OUT);
  input C, D, E, F;
  input [1:0] S;
  output MUX_OUT;
  reg MUX_OUT;
  always @(C or D or E or F or S)
  begin
    case (S)
      2'b00 : MUX_OUT = C;
      2'b01 : MUX_OUT = D;
      2'b10 : MUX_OUT = E;
      default : MUX_OUT = F;
    endcase
  end
endmodule
```

12:1 Multiplexor

The following examples infer a 12:1 multiplexor using a case statement.

VHDL

```
-- 12:1 mux
library ieee;
use ieee.std_logic_1164.all;

-- Entity declaration:
entity mux12_1 is
port
(
  mux_sel:   in std_logic_vector (3 downto 0);-- mux select
  A:        in std_logic;
  B:        in std_logic;
  C:        in std_logic;
  D:        in std_logic;
  E:        in std_logic;
  F:        in std_logic;
  G:        in std_logic;
  H:        in std_logic;
  I:        in std_logic;
  J:        in std_logic;
  K:        in std_logic;
  M:        in std_logic;
  mux_out:  out std_logic  -- mux output
);
end mux12_1;

-- Architectural body:
architecture synth of mux12_1 is

begin

  proc1: process (mux_sel, A, B, C, D, E, F, G, H, I, J, K, M)

  begin

    case mux_sel is
      when "0000" => mux_out<= A;
      when "0001" => mux_out <= B;
      when "0010" => mux_out <= C;
      when "0011" => mux_out <= D;
      when "0100" => mux_out <= E;
      when "0101" => mux_out <= F;
      when "0110" => mux_out <= G;
```

```
        when "0111"      => mux_out <= H;
        when "1000"      => mux_out <= I;
        when "1001"      => mux_out <= J;
        when "1010"      => mux_out <= K;
        when "1011"      => mux_out <= M;
        when others      => mux_out <= '0';

    end case;
end process procl;

end synth;
```

Verilog

```
// 12:1 mux
module mux12_1(mux_out,
              mux_sel, M, L, K, J, H, G, F, E, D, C, B, A
              );

    output          mux_out;
    input           [3:0] mux_sel;
    input           M;
    input           L;
    input           K;
    input           J;
    input           H;
    input           G;
    input           F;
    input           E;
    input           D;
    input           C;
    input           B;
    input           A;

    reg             mux_out;

    // create a 12:1 mux using a case statement
    always @ ({mux_sel[3:0]} or M or L or K or J or H or G or F or
             E or D or C or B or A)
    begin: mux_blk
        case ({mux_sel[3:0]}) // synthesis full_case parallel_case
            4'b0000 : mux_out = A;
            4'b0001 : mux_out = B;
            4'b0010 : mux_out = C;
            4'b0011 : mux_out = D;
            4'b0100 : mux_out = E;
            4'b0101 : mux_out = F;
            4'b0110 : mux_out = G;
        endcase
    end
endmodule
```

```

        4'b0111 :    mux_out = H;
        4'b1000 :    mux_out = J;
        4'b1001 :    mux_out = K;
        4'b1010 :    mux_out = L;
        4'b1011 :    mux_out = M;
        4'b1100 :    mux_out = 1'b0;
        4'b1101 :    mux_out = 1'b0;
        4'b1110 :    mux_out = 1'b0;
        4'b1111 :    mux_out = 1'b0;
    endcase
end
endmodule

```

Case X Multiplexor

The following Verilog example infers a multiplexor using a don't care case x statement. Actel does not recommend using don't care case x statements in VHDL. VHDL synthesis tools do not typically support the don't care value as well as Verilog tools.

Verilog

```

//8 bit 4:1 multiplexor with don't care X, 3:1 equivalent mux
module mux4 (a, b, c, sel, q);
input [7:0] a, b, c;
input [1:0] sel;
output [7:0] q;
reg [7:0] q;

always @ (sel or a or b or c)
casex (sel)
    2'b00: q = a;
    2'b01: q = b;
    2'b1x: q = c;
    default: q = c;
endcase
endmodule

```

Decoders

Decoders are used to decode data that has been previously encoded using binary or another type of encoding. The following examples infer a 3-8 line decoder with an enable.

VHDL

```
library IEEE;
use IEEE.std_logic_1164.all;

entity decode is
    port ( Ain : in std_logic_vector (2 downto 0);
          En: in std_logic;
          Yout : out std_logic_vector (7 downto 0));
end decode;

architecture decode_arch of decode is
begin
    process (Ain)
    begin
        if (En='0') then
            Yout <= (others => '0');
        else
            case Ain is
                when "000" => Yout <= "00000001";
                when "001" => Yout <= "00000010";
                when "010" => Yout <= "00000100";
                when "011" => Yout <= "00001000";
                when "100" => Yout <= "00010000";
                when "101" => Yout <= "00100000";
                when "110" => Yout <= "01000000";
                when "111" => Yout <= "10000000";
                when others => Yout <= "00000000";
            end case;
        end if;
    end process;
end decode_arch;
```

Verilog

```
module decode (Ain, En, Yout);
    input En;
    input [2:0] Ain;
    output [7:0] Yout;

    reg [7:0] Yout;

    always @ (En or Ain)
```



```
begin
  if (!En)
    Yout = 8'b0;
  else
    case (Ain)
      3'b000 : Yout = 8'b00000001;
      3'b001 : Yout = 8'b00000010;
      3'b010 : Yout = 8'b00000100;
      3'b011 : Yout = 8'b00001000;
      3'b100 : Yout = 8'b00010000;
      3'b101 : Yout = 8'b00100000;
      3'b110 : Yout = 8'b01000000;
      3'b111 : Yout = 8'b10000000;
      default : Yout = 8'b00000000;
    endcase
  end
endmodule
```

Counters

Counters count the number of occurrences of an event that occur either randomly or at uniform intervals. You can infer a counter in your design. However, most synthesis tools cannot infer optimal implementations of counters higher than 8-bits. If your counter is in the critical path of a speed and area critical design, Actel recommends that you use the ACTgen Macro Builder to build a counter. Once generated, instantiate the ACTgen counter in your design. Refer to “ACTgen Counter” on page 79 for examples of ACTgen counter instantiation. The following examples infer different types of counters.

8-bit Up Counter with Count Enable and Asynchronous Reset

The following examples infer an 8-bit up counter with count enable and asynchronous reset.

VHDL

```
library IEEE;
use IEEE.std_logic_1164.all;
use IEEE.std_logic_unsigned.all;
use IEEE.std_logic_arith.all;

entity counter8 is
port (clk, en, rst      : in std_logic;
      count            : out std_logic_vector (7 downto 0));
end counter8;

architecture behav of counter8 is
signal cnt: std_logic_vector (7 downto 0);
begin
process (clk, en, cnt, rst)
begin
    if (rst = '0') then
        cnt <= (others => '0');
    elsif (clk'event and clk = '1') then
        if (en = '1') then
            cnt <= cnt + '1';
        end if;
    end process;
    count <= cnt;
end behav;
```

Verilog

```
module count_en (en, clock, reset, out);
parameter Width = 8;
input clock, reset, en;
output [Width-1:0] out;
reg [Width-1:0] out;

always @(posedge clock or negedge reset)
    if(!reset)
        out = 8'b0;
    else if(en)
        out = out + 1;
endmodule
```

8-bit Up Counter with Load and Asynchronous Reset

The following examples infer an 8-bit up counter with load and asynchronous reset.

VHDL

```

library IEEE;
use IEEE.std_logic_1164.all;
use IEEE.std_logic_unsigned.all;
use IEEE.std_logic_arith.all;

entity counter is
    port (clk, reset, load: in std_logic;
          data: in std_logic_vector (7 downto 0);
          count: out std_logic_vector (7 downto 0));
end counter;

architecture behave of counter is
    signal count_i : std_logic_vector (7 downto 0);
begin
    process (clk, reset)
    begin
        if (reset = '0') then
            count_i <= (others => '0');
        elsif (clk'event and clk = '1') then
            if load = '1' then
                count_i <= data;
            else
                count_i <= count_i + '1';
            end if;
        end if;
    end process;
    count <= count_i;
end behave;

```

Verilog

```

module count_load (out, data, load, clk, reset);
    parameter Width = 8;
    input load, clk, reset;
    input [Width-1:0] data;
    output [Width-1:0] out;
    reg [Width-1:0] out;

    always @(posedge clk or negedge reset)
        if(!reset)
            out = 8'b0;
        else if(load)
            out = data;
        else
            out = out + 1;
endmodule

```

8-bit Up Counter with Load, Count Enable, Terminal Count and Asynchronous Reset

The following examples infer an 8-bit up counter with load, count enable, terminal count, and asynchronous reset.

Verilog

```
module count_load (out, cout, data, load, clk, en, reset);
parameter Width = 8;
    input load, clk, en, reset;
    input [Width-1:0] data;
    output cout; // carry out
    output [Width-1:0] out;
    reg [Width-1:0] out;

always @(posedge clk or negedge reset)
    if(!reset)
        out = 8'b0;
    else if(load)
        out = data;
    else if(en)
        out = out + 1;
// cout=1 when all out bits equal 1
assign cout = &out;

endmodule
```

N-bit Up Counter with Load, Count Enable, and Asynchronous Reset

The following examples infer an n-bit up counter with load, count enable, and asynchronous reset.

VHDL

```
library IEEE;
use IEEE.std_logic_1164.all;
use IEEE.std_logic_unsigned.all;
use IEEE.std_logic_arith.all;

entity counter is
generic (width : integer := n);
port (data : in std_logic_vector (width-1 downto 0);
      load, en, clk, rst : in std_logic;
      q : out std_logic_vector (width-1 downto 0));
end counter;
```

```

architecture behave of counter is
signal count : std_logic_vector (width-1 downto 0);
begin
process(clk, rst)
begin
    if rst = '1' then
        count <= (others => '0');
    elsif (clk'event and clk = '1') then
        if load = '1' then
            count <= data;
        elsif en = '1' then
            count <= count + '1';
        end if;
    end if;
end process;
q <= count;
end behave;

```

Arithmetic Operators

Synthesis tools generally are able to infer arithmetic operators for the target technology. The following examples infer addition, subtraction, division and multiplication operators.

VHDL

```

library IEEE;
use IEEE.std_logic_1164.all;
use IEEE.std_logic_arith.all;
use IEEE.std_logic_unsigned.all;

entity arithmetic is
port (A, B: in std_logic_vector(3 downto 0);
      Q1: out std_logic_vector(4 downto 0);
      Q2, Q3: out std_logic_vector(3 downto 0);
      Q4: out std_logic_vector(7 downto 0));
end arithmetic;

architecture behav of arithmetic is
begin
process (A, B)
begin
    Q1 <= ('0' & A) + ('0' & B); --addition
    Q2 <= A - B; --subtraction
    Q3 <= A / B; --division
    Q4 <= A * B; --multiplication
end process;
end behav;

```

If the multiply and divide operands are powers of 2, replace them with shift registers. Shift registers provide speed optimized implementations with large savings in area. For example:

```
Q <= C/16 + C*4;
```

can be represented as:

```
Q <= shr (C, "100") + shl (C, "10");
```

or

```
VHDL Q <= "0000" & C (8 downto 4) + C (6 downto 0) & "00";
```

The functions “shr” and “shl” are available in the IEEE.std_logic_arith.all library.

Verilog

```
module arithmetic (A, B, Q1, Q2, Q3, Q4);  
  input [3:0] A, B;  
  output [4:0] Q1;  
  output [3:0] Q2, Q3;  
  output [7:0] Q4;  
  reg [4:0] Q1;  
  reg [3:0] Q2, Q3;  
  reg [7:0] Q4;  
always @ (A or B)  
begin  
  Q1 = A + B; //addition  
  Q2 = A - B; //subtraction  
  Q3 = A / 2; //division  
  Q4 = A * B; //multiplication  
end  
endmodule
```

If the multiply and divide operands are powers of 2, replace them with shift registers. Shift registers provide speed optimized implementations with large savings in area. For example:

```
Q = C/16 + C*4;
```

can be represented as:

```
Q = {4b'0000 C[8:4]} + {C[6:0] 2b'00};
```

Relational Operators

Relational operators compare two operands and indicate whether the comparison is true or false. The following examples infer greater than, less than, greater than equal to, and less than equal to comparators. Synthesis tools generally optimize relational operators for the target technology.

VHDL

```

library IEEE;
use IEEE.std_logic_1164.all;
use IEEE.std_logic_arith.all;

entity relational is
port (A, B : in std_logic_vector(3 downto 0);
      Q1, Q2, Q3, Q4 : out std_logic);
end relational;

architecture behav of relational is
begin
process (A, B)
begin
-- Q1 <= A > B; -- greater than
-- Q2 <= A < B; -- less than
-- Q3 <= A >= B; -- greater than equal to
if (A <= B) then -- less than equal to
  Q4 <= '1';
else
  Q4 <= '0';
end if;
end process;
end behav;

```

Verilog

```

module relational (A, B, Q1, Q2, Q3, Q4);
input [3:0] A, B;
output Q1, Q2, Q3, Q4;
reg Q1, Q2, Q3, Q4;

always @ (A or B)
begin
// Q1 = A > B; //greater than
// Q2 = A < B; //less than
// Q3 = A >= B; //greater than equal to
if (A <= B) //less than equal to
  Q4 = 1;
else
  Q4 = 0;
end
endmodule

```

Equality Operator

The equality and non-equality operators indicate a true or false output based on whether the two operands are equivalent or not. The following examples infer equality operators.

VHDL

```
library IEEE;
use IEEE.std_logic_1164.all;

entity equality is
port (
    A: in STD_LOGIC_VECTOR (3 downto 0);
    B: in STD_LOGIC_VECTOR (3 downto 0);
    Q1: out STD_LOGIC;
    Q2: out STD_LOGIC
);
end equality;

architecture equality_arch of equality is
begin
    process (A, B)
    begin
        Q1 <= A = B; -- equality
        if (A /= B) then -- inequality
            Q2 <= '1';
        else
            Q2 <= '0';
        end if;
    end process;
end equality_arch;
```

OR

```
library IEEE;
use IEEE.std_logic_1164.all;

entity equality is
port (
    A: in STD_LOGIC_VECTOR (3 downto 0);
    B: in STD_LOGIC_VECTOR (3 downto 0);
    Q1: out STD_LOGIC;
    Q2: out STD_LOGIC
);
end equality;

architecture equality_arch of equality is
begin
    Q1 <= '1' when A = B else '0'; -- equality
    Q2 <= '1' when A /= B else '0'; -- inequality
end equality_arch;
```

Verilog

```

module equality (A, B, Q1, Q2);
  input [3:0] A;
  input [3:0] B;
  output Q1;
  output Q2;
  reg Q1, Q2;

  always @ (A or B)
  begin
    Q1 = A == B; //equality
    if (A != B) //inequality
      Q2 = 1;
    else
      Q2 = 0;
    end
  endmodule

```

Shift Operators

Shift operators shift data left or right by a specified number of bits. The following examples infer left and right shift operators.

VHDL

```

library IEEE;
use IEEE.std_logic_1164.all;
use IEEE.std_logic_arith.all;
use IEEE.std_logic_unsigned.all;

entity shift is
  port (data : in std_logic_vector(3 downto 0);
        q1, q2 : out std_logic_vector(3 downto 0));
end shift;

architecture rtl of shift is
  begin
    process (data)
    begin
      q1 <= shl (data, "10"); -- logical shift left
      q2 <= shr (data, "10"); --logical shift right
    end process;
  end rtl;

```

OR

```
library IEEE;
use IEEE.std_logic_1164.all;

entity shift is
port (data : in std_logic_vector(3 downto 0);
      q1, q2 : out std_logic_vector(3 downto 0));
end shift;

architecture rtl of shift is
begin
  process (data)
  begin
    q1 <= data(1 downto 0) & "10"; -- logical shift left
    q2 <= "10" & data(3 downto 2); --logical shift right
  end process;
end rtl;
```

Verilog

```
module shift (data, q1, q2);
  input [3:0] data;
  output [3:0] q1, q2;

  parameter B = 2;
  reg [3:0] q1, q2;

  always @ (data)
  begin
    q1 = data << B; // logical shift left
    q2 = data >> B; //logical shift right
  end
endmodule
```

Finite State Machine

A finite state machine (FSM) is a type of sequential circuit that is designed to sequence through specific patterns of finite states in a predetermined sequential manner. There are two types of FSM, Mealy and Moore. The Moore FSM has outputs that are a function of current state only. The Mealy FSM has outputs that are a function of the current state and primary inputs. An FSM consists of three parts:

1. **Sequential Current State Register:** The register, a set of n-bit flip-flops (state vector flip-flops) clocked by a single clock signal is used to hold the state vector (current state or simply state) of the FSM. A state vector with a length of n-bit has 2^n possible binary patterns, known as state encoding. Often, not all 2^n patterns are needed, so the unused ones should be designed not to occur during normal operation. Alternatively, an FSM with m-state requires at least $\log_2(m)$ state vector flip-flops.
2. **Combinational Next State Logic:** An FSM can only be in one state at any given time, and each active transition of the clock causes it to change from its current state to the next state, as defined by the next state logic. The next state is a function of the FSM's inputs and its current state.
3. **Combinational Output Logic:** Outputs are normally a function of the current state and possibly the FSM's primary inputs (in the case of a Mealy FSM). Often in a Moore FSM, you may want to derive the outputs from the next state instead of the current state, when the outputs are registered for faster clock-to-out timings.

Moore and Mealy FSM structures are shown in Figure 2-14 and Figure 2-15.

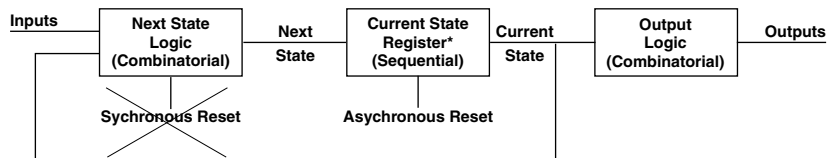

* State Vector Flip-flops

Figure 2-14. Basic Structure of a Moore FSM

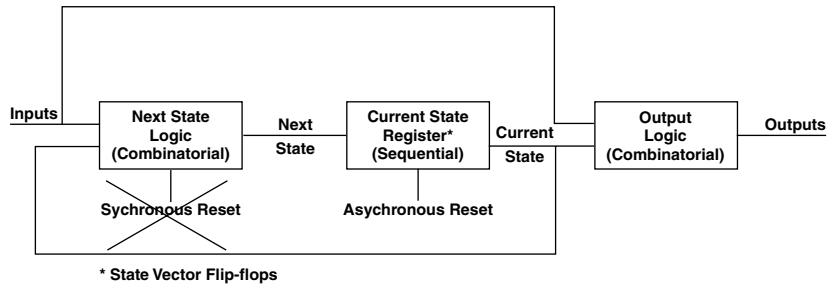

Figure 2-15. Basic Structure of a Mealy FSM

Use a reset to guarantee fail-safe behavior. This ensures that the FSM is always initialized to a known valid state before the first active clock transition and normal operation begins. In the absence of a reset, there is no way of predicting the initial value of the state register flip-flops during the “power up” operation of an Actel FPGA. It could power up and become permanently stuck in an unencoded state. The reset should be implemented in the sequential current state process of the FSM description.

An asynchronous reset is generally preferred over a synchronous reset because an asynchronous reset does not require decoding unused states, minimizing the next state logic.

Because FPGA technologies are register rich, “one hot” state machine implementations generated by the synthesis tool may generate optimal area and performance results

Mealy Machine

The following examples represent a Mealy FSM model for the Mealy state diagram shown in Figure 2-16.

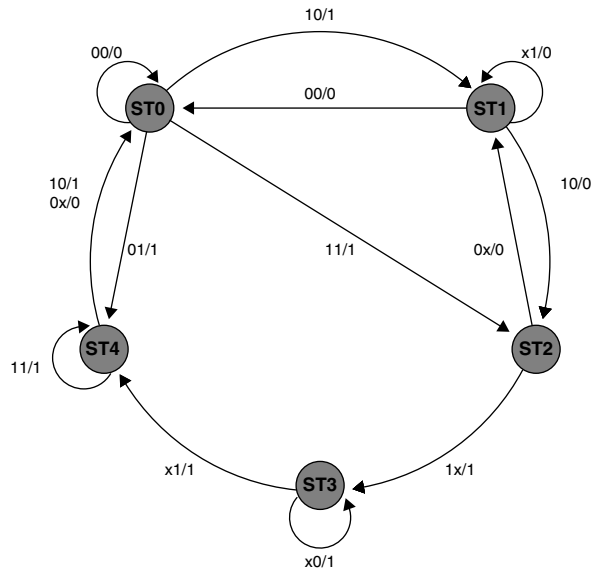

Figure 2-16. Mealy State Diagram

VHDL

```
-- Example of a 5-state Mealy FSM

library ieee;
use ieee.std_logic_1164.all;

entity mealy is
  port (clock, reset: in std_logic;
        data_out: out std_logic;
        data_in: in std_logic_vector (1 downto 0));
end mealy;

architecture behave of mealy is
  type state_values is (st0, st1, st2, st3, st4);
  signal pres_state, next_state: state_values;
begin
  -- FSM register
  statereg: process (clock, reset)
  begin
```

```
    if (reset = '0') then
        pres_state <= st0;
    elsif (clock'event and clock = '1') then
        pres_state <= next_state;
    end if;
end process statereg;

-- FSM combinational block
fsm: process (pres_state, data_in)
begin
    case pres_state is
        when st0 =>
            case data_in is
                when "00" => next_state <= st0;
                when "01" => next_state <= st4;
                when "10" => next_state <= st1;
                when "11" => next_state <= st2;
                when others => next_state <= (others <= 'x');
            end case;
        when st1 =>
            case data_in is
                when "00" => next_state <= st0;
                when "10" => next_state <= st2;
                when others => next_state <= st1;
            end case;
        when st2 =>
            case data_in is
                when "00" => next_state <= st1;
                when "01" => next_state <= st1;
                when "10" => next_state <= st3;
                when "11" => next_state <= st3;
                when others => next_state <= (others <= 'x');
            end case;
        when st3 =>
            case data_in is
                when "01" => next_state <= st4;
                when "11" => next_state <= st4;
                when others => next_state <= st3;
            end case;
        when st4 =>
            case data_in is
                when "11" => next_state <= st4;
                when others => next_state <= st0;
            end case;
        when others => next_state <= st0;
    end case;
end process fsm;
```

```

-- Mealy output definition using pres_state w/ data_in
outputs: process (pres_state, data_in)
begin
  case pres_state is
    when st0 =>
      case data_in is
        when "00" => data_out <= '0';
        when others => data_out <= '1';
      end case;
    when st1 => data_out <= '0';
    when st2 =>
      case data_in is
        when "00" => data_out <= '0';
        when "01" => data_out <= '0';
        when others => data_out <= '1';
      end case;
    when st3 => data_out <= '1';
    when st4 =>
      case data_in is
        when "10" => data_out <= '1';
        when "11" => data_out <= '1';
        when others => data_out <= '0';
      end case;
    when others => data_out <= '0';
  end case;
end process outputs;

end behave;

```

Verilog

```

// Example of a 5-state Mealy FSM

module mealy (data_in, data_out, reset, clock);
output data_out;
input [1:0] data_in;
input reset, clock;

reg data_out;
reg [2:0] pres_state, next_state;

parameter st0=3'd0, st1=3'd1, st2=3'd2, st3=3'd3, st4=3'd4;

// FSM register
always @ (posedge clock or negedge reset)
begin: statereg
if(!reset)// asynchronous reset

```

```
pres_state = st0;
    else
        pres_state = next_state;
    end // statereg

// FSM combinational block
always @(pres_state or data_in)
begin: fsm
    case (pres_state)
        st0:    case (data_in)
            2'b00:    next_state=st0;
            2'b01:    next_state=st4;
            2'b10:    next_state=st1;
            2'b11:    next_state=st2;
        endcase
        st1:    case (data_in)
            2'b00:    next_state=st0;
            2'b10:    next_state=st2;
            default:  next_state=st1;
        endcase
        st2:    case (data_in)
            2'b0x:    next_state=st1;
            2'b1x:    next_state=st3;
        endcase
        st3:    case (data_in)
            2'bx1:    next_state=st4;
            default:  next_state=st3;
        endcase
        st4:    case (data_in)
            2'b11:    next_state=st4;
            default:  next_state=st0;
        endcase
    default:    next_state=st0;
    endcase
end // fsm

// Mealy output definition using pres_state w/ data_in
always @(data_in or pres_state)
begin: outputs
    case (pres_state)
        st0:    case (data_in)
            2'b00:    data_out=1'b0;
            default:  data_out=1'b1;
        endcase
        st1:    data_out=1'b0;
        st2:    case (data_in)
```



```

        2'b0x:      data_out=1'b0;
        default:   data_out=1'b1;
    endcase
    st3:          data_out=1'b1;
    st4:          case(data_in)
        2'b1x:      data_out=1'b1;
        default:    data_out=1'b0;
    endcase
    default:      data_out=1'b0;
endcase
end // outputs

endmodule

```

Moore Machine

The following examples represent a Moore FSM model for the Mealy state diagram shown in Figure 2-16 on page 39.

VHDL

```

-- Example of a 5-state Moore FSM

library ieee;
use ieee.std_logic_1164.all;

entity moore is
    port (clock, reset: in std_logic;
          data_out: out std_logic;
          data_in: in std_logic_vector (1 downto 0));
end moore;

architecture behave of moore is
    type state_values is (st0, st1, st2, st3, st4);
    signal pres_state, next_state: state_values;
begin
    -- FSM register
    statereg: process (clock, reset)
    begin
        if (reset = '0') then
            pres_state <= st0;
        elsif (clock = '1' and clock'event) then
            pres_state <= next_state;
        end if;
    end process statereg;

```

```
-- FSM combinational block
fsm: process (pres_state, data_in)
begin
  case pres_state is
    when st0 =>
      case data_in is
        when "00" => next_state <= st0;
        when "01" => next_state <= st4;
        when "10" => next_state <= st1;
        when "11" => next_state <= st2;
        when others => next_state <= (others <= 'x');
      end case;
    when st1 =>
      case data_in is
        when "00" => next_state <= st0;
        when "10" => next_state <= st2;
        when others => next_state <= st1;
      end case;
    when st2 =>
      case data_in is
        when "00" => next_state <= st1;
        when "01" => next_state <= st1;
        when "10" => next_state <= st3;
        when "11" => next_state <= st3;
        when others => next_state <= (others <= 'x');
      end case;
    when st3 =>
      case data_in is
        when "01" => next_state <= st4;
        when "11" => next_state <= st4;
        when others => next_state <= st3;
      end case;
    when st4 =>
      case data_in is
        when "11" => next_state <= st4;
        when others => next_state <= st0;
      end case;
    when others => next_state <= st0;
  end case;
end process fsm;

-- Moore output definition using pres_state only
outputs: process (pres_state)
begin
  case pres_state is
    when st0 => data_out <= '1';
    when st1 => data_out <= '0';
```

```

        when st2    => data_out <= '1';
        when st3    => data_out <= '0';
        when st4    => data_out <= '1';
        when others => data_out <= '0';
    end case;
end process outputs;

end behave;

```

Verilog

```

// Example of a 5-state Moore FSM

module moore (data_in, data_out, reset, clock);
    output data_out;
    input [1:0] data_in;
    input reset, clock;

    reg data_out;
    reg [2:0] pres_state, next_state;

    parameter st0=3'd0, st1=3'd1, st2=3'd2, st3=3'd3, st4=3'd4;

    //FSM register
    always @(posedge clock or negedge reset)
    begin: statereg
        if(!reset)
            pres_state = st0;
        else
            pres_state = next_state;
    end // statereg

    // FSM combinational block
    always @(pres_state or data_in)
    begin: fsm
        case (pres_state)
            st0:    case (data_in)
                2'b00:    next_state=st0;
                2'b01:    next_state=st4;
                2'b10:    next_state=st1;
                2'b11:    next_state=st2;
            endcase
            st1:    case (data_in)
                2'b00:    next_state=st0;
                2'b10:    next_state=st2;
                default:  next_state=st1;
            endcase
        endcase
    end

```

```
st2:    case(data_in)
        2'b0x:    next_state=st1;
        2'b1x:    next_state=st3;
    endcase
st3:    case(data_in)
        2'bx1:    next_state=st4;
        default:  next_state=st3;
    endcase
st4:    case(data_in)
        2'b11:    next_state=st4;
        default:  next_state=st0;
    endcase
default:    next_state=st0;
endcase
end // fsm

// Moore output definition using pres_state only
always @(pres_state)
begin: outputs
    case(pres_state)
        st0:    data_out=1'b1;
        st1:    data_out=1'b0;
        st2:    data_out=1'b1;
        st3:    data_out=1'b0;
        st4:    data_out=1'b1;
        default: data_out=1'b0;
    endcase
end // outputs

endmodule // Moore
```

Input-Output Buffers

You can infer or instantiate a I/O buffers in your design. The following examples represent both techniques. Regardless of which method you use, all I/O buffers should be declared at the top level of the design.

Tri-State Buffer

A tri-state buffer is an output buffer with high-impedance capability. The following examples show how to infer and instantiate a tri-state buffer.

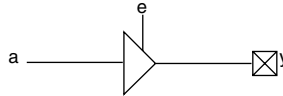

Figure 2-17. Tri-State Buffer

Inference

VHDL

```
library IEEE;
use IEEE.std_logic_1164.all;

entity tristate is
port (e, a : in std_logic;
      y : out std_logic);
end tristate;

architecture tri of tristate is
begin
  process (e, a)
  begin
    if e = '1' then
      y <= a;
    else
      y <= 'Z';
    end if;
  end process;
end tri;
```

OR

```
library IEEE;
use IEEE.std_logic_1164.all;

entity tristate is
port (e, a : in std_logic;
      y : out std_logic);
end tristate;

architecture tri of tristate is
begin
  Y <= a when (e = '1') else 'Z';
end tri;
```

Verilog

```
module TRISTATE (e, a, y);
  input a, e;
  output y;
  reg Y;
  always @ (e or a) begin
    if (e)
      y = a;
    else
      y = 1'bz;
    end
endmodule
```

OR

```
module TRISTATE (e, a, y);
  input a, e;
  output y;

  assign y = e ? a : 1'bZ;

endmodule
```

Instantiation

VHDL

```
library IEEE;
use IEEE.std_logic_1164.all;

entity tristate is
  port (e, a : in std_logic;
        y : out std_logic);
end tristate;

architecture tri of tristate is

  component TRIBUFF
    port (D, E: in std_logic;
          PAD: out std_logic);
  end component;

  begin
    U1: TRIBUFF port map (D => a,
                        E => e,
                        PAD => y);
  end tri;
```

Verilog

```

module TRISTATE (e, a, y);
input a, e;
output y;

TRIBUFF U1 (.D(a), .E(e), .PAD(y));

endmodule

```

Bi-Directional Buffer

A bi-directional buffer can be an input or output buffer with high impedance capability. The following examples show how to infer and instantiate a bi-directional buffer.

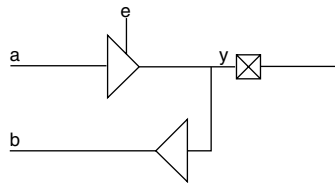

Figure 2-18. Bi-Directional Buffer

Inference

VHDL

```

library IEEE;
use IEEE.std_logic_1164.all;

entity bidir is
port (y : inout std_logic;
      e, a: in std_logic;
      b : out std_logic);
end bidir;

architecture bi of bidir is
begin
  begin
    process (e, a)
    begin
      case e is
        when '1' => y <= a;
        when '0' => y <= 'Z';
        when others => y <= 'X';
      end case;
    end process;
    b <= y;
  end
end architecture bi;

```

```
end bi;
```

Verilog

```
module bidir (e, y, a, b);
    input a, e;
    inout y;
    output b;
    reg y_int;
    wire y, b;

    always @ (a or e)
    begin
        if (e == 1'b1)
            y_int <= a;
        else
            y_int <= 1'bz;
        end
    assign y = y_int;
    assign b = y;
endmodule
```

Instantiation

VHDL

```
library IEEE;
use IEEE.std_logic_1164.all;

entity bidir is
    port (y : inout std_logic;
          e, a: in std_logic;
          b : out std_logic);
end bidir;

architecture bi of bidir is

    component BIBUF
        port (D, E: in std_logic;
              Y : out std_logic;
              PAD: inout std_logic);
    end component;

    begin
    U1: BIBUF port map (D => a,
                       E => e,
                       Y => b,
```



```

        PAD => y);
end bi;

```

Verilog

```

module bidir (e, y, a, b);
    input a, e;
    inout y;
    output b;

    BBUF U1 ( .PAD(y), .D(a), .E(e), .Y(b) );

endmodule

```

Generics and Parameters

Generics and parameters are used to define the size of a component. This allows the design of parameterized components for the size and feature sets that may be defined by values of the instantiation parameters. The following examples show how to use generics and parameters when describing a parameterized adder. Furthermore, this adder is instantiated for varying widths.

VHDL

```

library IEEE;
use IEEE.std_logic_1164.all;
use IEEE.std_logic_arith.all;
use IEEE.std_logic_unsigned.all;

entity adder is
    generic (WIDTH : integer := 8);
    port (A, B: in UNSIGNED(WIDTH-1 downto 0);
          CIN: in std_logic;
          COUT: out std_logic;
          Y: out UNSIGNED(WIDTH-1 downto 0));
end adder;

architecture rtl of adder is
begin
    process (A,B,CIN)
        variable TEMP_A,TEMP_B,TEMP_Y:UNSIGNED(A'length downto 0);
    begin
        TEMP_A := '0' & A;
        TEMP_B := '0' & B;
        TEMP_Y := TEMP_A + TEMP_B + CIN;
        Y <= TEMP_Y (A'length-1 downto 0);
    end process;
end architecture;

```

```
        COUT <= TEMP_Y (A'length);  
    end process;  
end rtl;
```

“Width” indicates the width of the adder. The instantiation for this parameterized adder for a bit width of 16 is:

```
U1: adder generic map(16) port map (A_A, B_A, CIN_A, COUT_A,  
Y_A);
```

Verilog

```
module adder (cout, sum, a, b, cin);  
    parameter Size = 8;  
    output cout;  
    output [Size-1:0] sum;  
    input cin;  
    input [Size-1:0] a, b;  
  
    assign {cout, sum} = a + b + cin;  
  
endmodule
```

“Size” indicates the width of the adder. The instantiation for this parameterized adder for a bit width of 16 is:

```
adder #(16) adder16(cout_A, sun_A, a_A, b_A, cin_A)
```

Performance Driven Coding

Unlike ASICs, FPGAs are module based arrays. Each logic level used on a path can add delay. As a result, meeting timing constraints on a critical path with too many logic levels becomes difficult. Using an efficient coding style is very important because it dictates the synthesis logic implementation. This chapter describes synthesis implementations, techniques, and efficient design practices that can be used to reduce logic levels on a critical path.

Reducing Logic Levels on Critical Paths

Each logic level on the critical path in an FPGA can add significant delay. To ensure that timing constraints can be met, logic level usage must be considered when describing the behavior of a design. The following examples illustrate how to reduce logic levels on critical paths.

Example 1

In the following VHDL example, the signal “critical” goes through three logic levels.

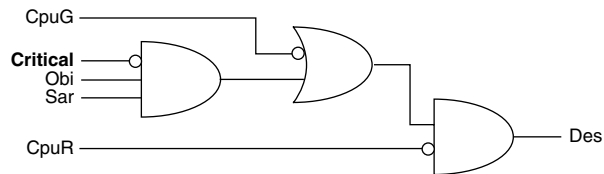

```

if ((( Crtical='0' and Obi='1' and Sar='1')
or CpuG='0') and CpuR='0') then
    Des <= Adr;
elsif (((Crtical='0' and Obi='1' and Sar='1')
or CpuG='0') and CpuR='1') then
    Des <= Bdr;
elsif (Sar='0' and .....

```

The signal “critical” is a late arriving signal. To reduce the logic level usage on “critical”, imply priority by using an if-then-else statement. As a result, the signal “critical” goes through one logic level, as shown below.

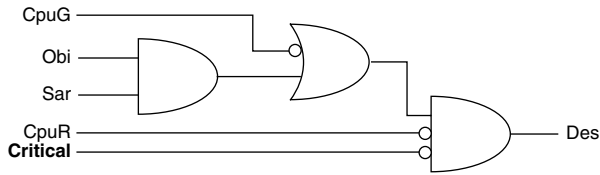

```
if (Critical='0') then
  if ((Obi='1' and Sar='1')
    or CpuG='0') and CpuR='0') then
    Des <= Adr;
  elsif ((Obi='1' and Sar='1')
    or CpuG='0' and CpuR='1') then
    Des <= Bdr;
  end if;
end if;
```

Example 2

In the following example, the signal “critical” goes through two logic levels.

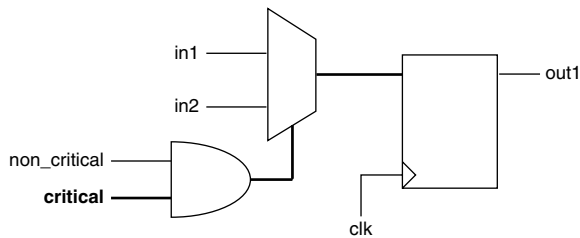

```
if (clk'event and clk ='1') then
  if (non_critical and critical) then
    out1 <= in1 ;
  else
    out1 <= in2 ;
  end if;
end if;
```

To reduce the logic level usage on “critical”, multiplex inputs “in1” and “in2” based on “non_critical”, and call this output “out_temp”. Then multiplex “out_temp” and “in2” based on “critical”. As a result, the signal “critical” goes through one logic level, as shown below.

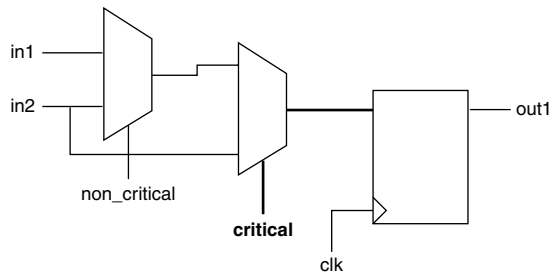

```
signal out_temp : std_logic
  if (non_critical)
    out_temp <= in1;
  else out_temp <= in2;
  if (clk'event and clk = '1') then
    if (critical) then
      out1 <= out_temp;
    else out1 <= in2;
    end if;
  end if;
end if;
```

Resource Sharing

Resource sharing can reduce the number of logic modules needed to implement HDL operations. Without it, each HDL description is built into a separate circuit. The following VHDL examples illustrate how to use resource sharing to reduce logic module utilization.

Example 1

This example implements four adders.

```
if (...(siz == 1)...)  
    count = count + 1;  
else if (...((siz ==2)...)  
    count = count + 2;  
else if (...(siz == 3)...)  
    count = count + 3;  
else if (...(siz == 0)...)  
    count = count + 4;
```

By adding the following code, two adders can be eliminated:

```
if (...(siz == 0)...)  
    count = count + 4;  
else if (...)  
    count = count + siz
```

Example 2

This example uses poor resource sharing to implement adders.

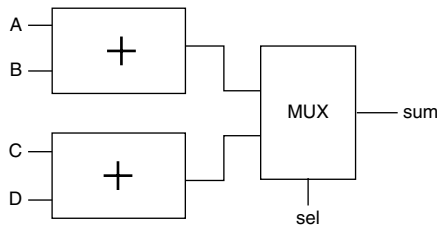

```
if (select)  
    sum <= A + B;  
else  
    sum <= C + D;
```

Adders use valuable resources. To reduce resource usage, rewrite the code to infer two multiplexers and one adder, as shown below.

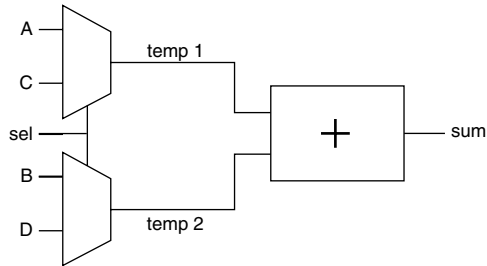

```
if (sel)
    temp1 <= A;
    temp2 <= B;
else
    temp1 <= C;
    temp2 <= D;
sum <= temp1 + temp2;
```

Note: This example assumes the select line is not a late arriving signal.

Operators Inside Loops

Operators are resource intensive compared to multiplexors. If there is an operator inside a loop, the synthesis tool has to evaluate all conditions. In the following VHDL example, the synthesis tool builds four adders and one multiplexor. This implementation is only advisable if the select line “req” is a late arriving signal.

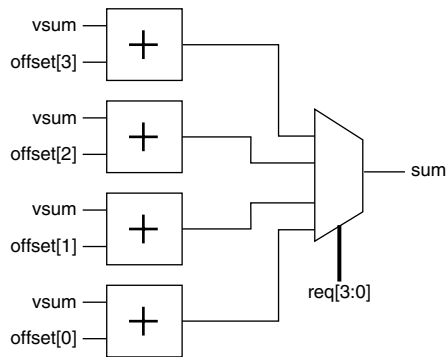

```
vsum := sum;  
for i in 0 to 3 loop  
  if (req(i)='1') then  
    vsum <= vsum + offset(i);  
  end if;  
end loop;
```

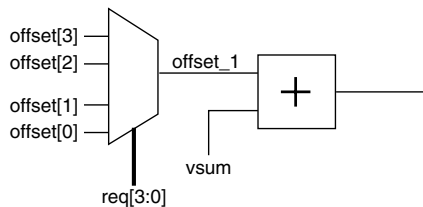

If the select line “req” is not critical, the operator should be moved outside the loop so the synthesis tool can multiplex the data before performing the adder operation. The area efficient design is implemented in a larger multiplexor and a single adder, as shown below.



```
vsum := sum;
for i in 0 to 3 loop
  if (req(i)='1') then
    offset_1 <= offset(i);
  end if;
end loop;
vsum <= vsum + offset_1;
```

Coding for Combinability

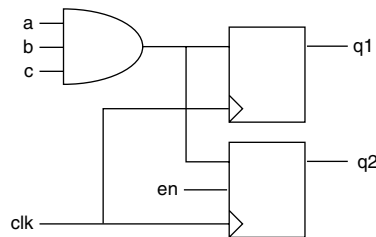
Combinatorial modules can be merged into sequential modules in the antifuse architecture. This results in a significant reduction in delay on the critical path as well as area reduction. However, cells are only merged if the combinatorial module driving a basic flip-flop has a load of 1. In the following VHDL example, the AND gate driving the flip-flop has a load of 2. As a result, the AND gate cannot be merged into the sequential module.



```
one :process (clk, a, b, c, en) begin
    if (clk'event and clk ='1') then
        if (en = '1') then
            q2 <= a and b and c;
        end if;
        q1 <= a and b and c;
    end if;
end process one;
```

To enable merging, the AND gate has to be duplicated so that it has a load of 1. To duplicate the AND gate, create two independent processes, as shown below. Once merged, one logic level has been removed from the critical path.

Note: Some synthesis tools automatically duplicate logic on the critical path. Other synthesis tools detect the function “a & b & c” in the two processes and share the function on a single gate. If the function is shared, the logic is not duplicated and you should consider instantiation.

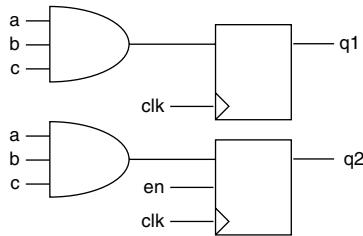

```
part_one: process (clk, a, b, c, en) begin
    if (clk'event and clk ='1') then
        if (en = '1') then
            q2 <= a and b and c;
        end if;
    end if;
end process part_one;
part_two: process (clk, a, b, c) begin
    if (clk'event and clk ='1') then
        q1 <= a and b and c;
    end if;
end process part_two;
```

Register Duplication

The delay on a net rises as the number of loads increase in the antifuse architecture. This is acceptable for networks such as reset, but not others such as tri-state enable, etc. It is important to keep the fanout of a network below 16. In the following VHDL example, the signal “Tri_en” has a fanout of 24.

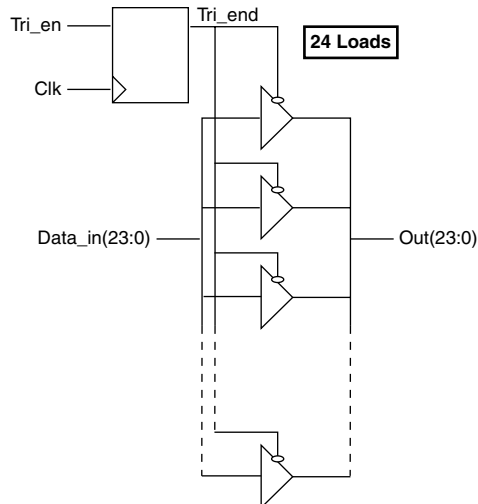

```
architecture load_of_four_load is
    signal Tri_en std_logic;
begin
    loadpro: process (Clk)
        begin
            if (clk'event and clk = '1') then
                Tri_end <= Tri_en;
            end if;
        end process loadpro;

    endpro : process (Tri_end, Data_in)
        begin
            if (Tri_end = '1') then
                out <= Data_in;
            else
                out <= (others => 'Z');
            end if;
        end process endpro;
end architecture load_of_four_load;
```

```

        end if;
    end process endpro;
end load;

```

To decrease the fanout by half, registers are duplicated on the signal “Tri_en” so the load is split in half, as shown in the following example.

Note: Some synthesis tools duplicate registers to resolve timing and fanout violations and do not require this coding technique.

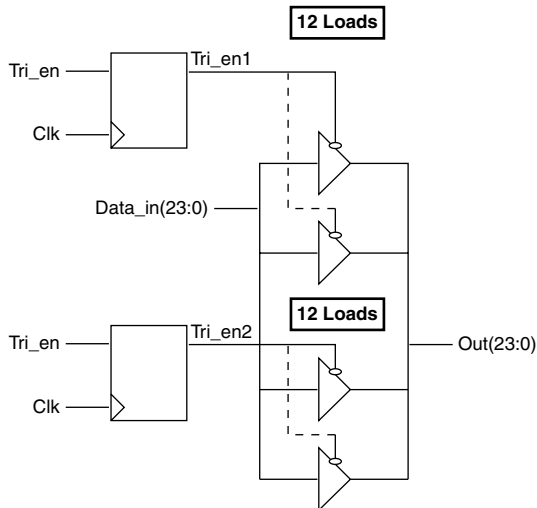

```

architecture loada of two_load is
    signal Tri_en1, Tri_en2 : std_logic;
begin
    loadpro: process (Clk)
    begin
        if (clk'event and clk = '1') then
            Tri_en1 <= Tri_en;
            Tri_en2 <= Tri_en;
        end if;
    end process loadpro;

    process (Tri_en1, Data_in)
    begin
        if (Tri_en1 = '1') then
            out(23:12) <= Data_in(23:12);
        else
            out(23:12) <= (others => 'Z');
        end if;
    end process;
end architecture loada;

```

```

        end if;
    end process;

    process (Tri_en2, Data_in)
    begin
        if (Tri_en2 = '1') then
            out(11:0) <= Data_in(11:0);
        else
            out(11:0) <= (others => 'Z');
        end if;
    end process;

```

Partitioning a Design

Most synthesis tools work best when optimizing medium sized blocks, approximately two to five thousand gates at a time. To reduce synthesis time, you should partition designs so that module block sizes do not exceed the recommendations of the synthesis tool vendor. When partitioning a design into various blocks, it is good design practice to have registers at hierarchical boundaries. This eliminates the need for time budgeting on the inputs and outputs. The following example shows how to modify your HDL code so that registers are placed at hierarchical boundaries.

Registers Embedded Within a Module

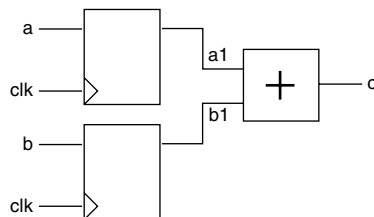

```
process (clk, a, b) begin
    if (clk'event and clk = '1') then
        a1 <= a;
        b1 <= b;
    end if;
end process;

process (a1, b1)
begin c <= a1 + b1;
end process;
```

**Registers
Pushed Out at
the
Hierarchical
Boundary**

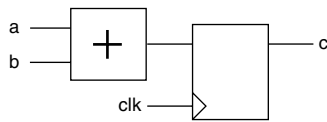

```
process (clk, a, b) begin
    if (clk'event and clk = '1') then
        c <= a + b;
    end if;
end process;
```

Technology Specific Coding Techniques

In addition to technology independent and performance driven coding, there are coding techniques that you can use to take advantage of the Actel architecture to improve speed and area utilization of your design. Additionally, most synthesis tools can implement random logic, control logic and certain datapath macros. However, they may not generate technology optimal implementations for datapath elements that cannot be inferred using operators, such as counters, RAM, FIFO, etc. This chapter describes coding techniques to take advantage of technology specific features and how to instantiate technology specific macros generated by the ACTgen Macro Builder tool for optimal area and performance.

Multiplexors

Using case statements with the multiplexor based Actel architecture provides area and speed efficient solutions and is more efficient than inference of priority encoders using if-then-else statements. Actel recommends that you use case statements instead of long, nested if-then-else statements to force mapping to multiplexors in the Actel architecture. Refer to “Multiplexors Using Case” on page 21 for examples of multiplexor coding.

VHDL synthesis tools automatically assume parallel operation without priority in case statements. However, some Verilog tools assume priority, and you may need to add a directive to your case statement to ensure that no priority is assumed. Refer to the documentation provided with your synthesis tool for information about creating case statements without priority.

Internal Tri-State to Multiplexor Mapping

All internal tri-states must be mapped to multiplexors. The antifuse technology only supports tri-states as in/out ports, but not internal tri-states. The following examples show an internal tri-state followed by a multiplexor that the internal tri-state should change to.

Note: Some synthesis tools automatically map internal tri-states to multiplexors.

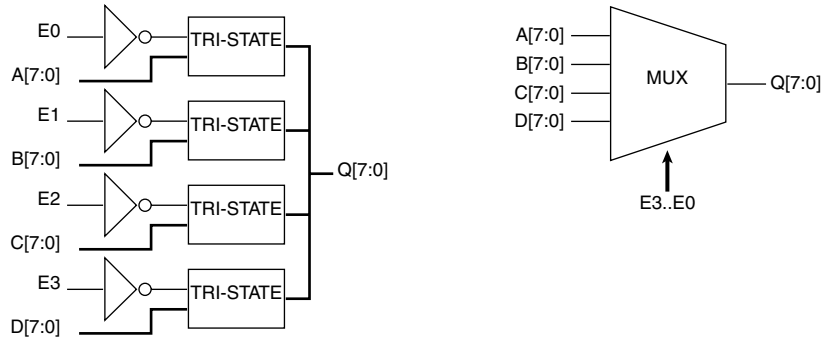

VHDL Tri-State

```

library IEEE;
use IEEE.std_logic_1164.all;
entity tribus is
port (A, B, C, D : in std_logic_vector(7 downto 0);
      E0, E1, E2, E3 : in std_logic;
      Q : out std_logic_vector(7 downto 0));
end tribus;

architecture rtl of tribus is
begin
  Q <= A when (E0 = '1') else "ZZZZZZZZ";
  Q <= B when (E1 = '1') else "ZZZZZZZZ";
  Q <= C when (E2 = '1') else "ZZZZZZZZ";
  Q <= D when (E3 = '1') else "ZZZZZZZZ";
end rtl;

```

VHDL Multiplexor

```

library IEEE;
use IEEE.std_logic_1164.all;
entity muxbus is
port (A, B, C, D : in std_logic_vector(7 downto 0);
      E0, E1, E2, E3 : in std_logic;
      Q : out std_logic_vector(7 downto 0));
end muxbus;

architecture rtl of muxbus is
signal E_int : std_logic_vector(1 downto 0);

```



```
begin
process (E0, E1, E2, E3)
variable E : std_logic_vector(3 downto 0);
begin
  E := E0 & E1 & E2 & E3;
case E is
  when "0001" => E_int <= "00";
  when "0010" => E_int <= "01";
  when "0100" => E_int <= "10";
  when "1000" => E_int <= "11";
  when others => E_int <= "--";
end case;
end process;

process (E_int, A, B, C, D)
begin
  case E_int is
  when "00" => Q <= D;
  when "01" => Q <= C;
  when "10" => Q <= B;
  when "11" => Q <= A;
  when others => Q <= (others => '-');
end case;
end process;
end rtl;
```

Verilog Tri-State

```
module tribus (A, B, C, D, E0, E1, E2, E3, Q);

  input [7:0]A, B, C, D;
  output [7:0]Q;
  input E0, E1, E2, E3;

  assign Q[7:0] = E0 ? A[7:0] : 8'bzzzzzzzz;
  assign Q[7:0] = E1 ? B[7:0] : 8'bzzzzzzzz;
  assign Q[7:0] = E2 ? C[7:0] : 8'bzzzzzzzz;
  assign Q[7:0] = E3 ? D[7:0] : 8'bzzzzzzzz;

endmodule
```

Verilog Multiplexor

```
module muxbus (A, B, C, D, E0, E1, E2, E3, Q);
  input [7:0]A, B, C, D;
  output [7:0]Q;
  input E0, E1, E2, E3;
  wire [3:0] select4;
  reg [1:0] select2;
  reg [7:0]Q;

  assign select4 = {E0, E1, E2, E3};
```

```
always @ (select4)
begin
  case(select4)
    4'b0001 : select2 = 2'b00;
    4'b0010 : select2 = 2'b01;
    4'b0100 : select2 = 2'b10;
    4'b1000 : select2 = 2'b11;
    default : select2 = 2'bxx;
  endcase
end

always @ (select2 or A or B or C or D)
begin
  case(select2)
    2'b00 : Q = D;
    2'b01 : Q = C;
    2'b10 : Q = B;
    2'b11 : Q = A;
  endcase
end

endmodule
```

Registers

The XL, DX, MX, SX and ACT 3 families have dedicated asynchronous reset registers in the sequential modules (SMOD). In each SMOD is a 4:1 multiplexor with some gating logic on the select lines.

Implementing a simple register or an asynchronous reset register allows the gating logic in front of the register to be pulled into the SMOD, reducing the path delay by one level. This is called full combinability. Full combinability offers improved speed, increasing a 50MHz operation to 75MHz in some designs. The following examples show how to use registers for combinability and discuss any speed or area penalty associated with using the register.

Synchronous Clear or Preset

The synchronous clear or preset register only uses part of the SMOD multiplexor, allowing for some combinability. The following example shows how to share a synchronous register with a 2:1 multiplexor.

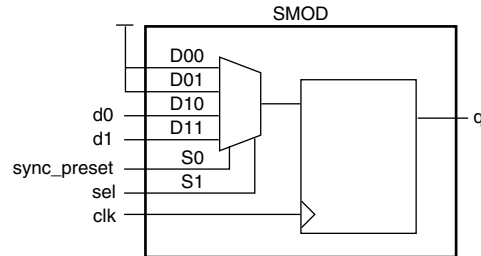

Figure 4-1. Single Module Implementation of a Synchronous Clear or Preset Register

VHDL

-- register with active low sync preset shared with a 2-to-1 mux.

```
library ieee;
use ieee.std_logic_1164.all;
entity dfm_sync_preset is
  PORT (d0, d1: in std_logic;
        clk, preset, sel: in std_logic;
        q: out std_logic;
  end dfm_sync_preset;

architecture behav of dfm_sync_preset is
  signal tmp_sel: std_logic_vector(1 downto 0);
  signal q_tmp: std_logic;
begin
  process (clk) begin
    tmp_sel <= preset & sel;
    if (clk'event and clk = '1') then
      case tmp_sel is
        when "00" => q_tmp <= '1';
        when "01" => q_tmp <= '1';
        when "10" => q_tmp <= d0;
        when "11" => q_tmp <= d1;
        when others => q_tmp <= '1';
      end case;
    end if;
  end process;
  q <= q_tmp;
```

```
end behav;
```

Verilog

```
/* register with active-low synchronous preset shared with
2-to-1 mux */

module dfm_sync_preset (d0, d1, clk, sync_preset, sel, q);
input d0, d1;
input sel;
input clk, sync_preset;
output q;
reg q;
always @ (posedge clk)
begin
  case ({sync_preset, sel})
    2'b00: q = 1'b1;
    2'b01: q = 1'b1;
    2'b10: q = d0;
    2'b11: q = d1;
  endcase
end
endmodule
```

Clock Enabled

The clock enabled register uses a 2:1 multiplexor with output feedback, which uses some of the SMOD multiplexor. The following example shows how to share a clock enabled register with the input logic.

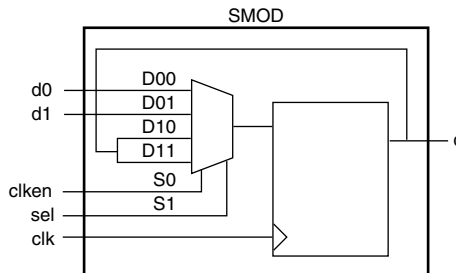

Figure 4-2. Single Module Implementation of a Clock Enabled Register

VHDL

```
-- register with active low async reset, shared with a 2-to-1
-- mux, and an active high clock enable.
```

```
library ieee;
use ieee.std_logic_1164.all;
entity dfm_clken is
PORT (d0, d1: in std_logic;
      clk, reset, clken, sel: in std_logic;
      q: out std_logic;
end dfm_clken;

architecture behav of dfm_clken is
signal tmp_sel: std_logic_vector(1 downto 0);
signal q_tmp: std_logic;
begin
process (clk, reset) begin
tmp_sel <= clken & sel;
if (reset = '0') then
q_tmp <= '0';
elsif (clk'event and clk = '1') then
case tmp_sel is
when "00" => q_tmp <= d0;
when "01" => q_tmp <= d1;
when "10" => q_tmp <= q_tmp;
when "11" => q_tmp <= q_tmp;
when others => q_tmp <= q_tmp;
end case;
end if;
end process;
q <= q_tmp;
end behav;
```

Verilog

```
/* register with asynchronous reset, clock enable,
shared with a 2-to-1 mux */

module dfm_clken (d0, d1, clk, reset, clken, sel, q);
input d0, d1;
input sel;
input clk, reset, clken;
output q;
reg q;
always @ (posedge clk or negedge reset)
begin
    if (!reset)
        q = 1'b0;
    else
        case ({clken, sel})
            2'b00: q = d0;
            2'b01: q = d1;
            2'b10: q = q;
            2'b11: q = q;
        endcase
    end
endmodule
```

Asynchronous Preset

Some synthesis tools automatically translate an asynchronous preset register into an asynchronous reset register without performance penalties. The bubbled logic can then be pushed into the surrounding logic without any delay penalty. There are various types of preset registers in the Actel libraries. Some of the registers use two combinatorial modules (CMOD) and most use an inverter, which consumes part of the SMOD multiplexer. If your synthesis tool does not automatically translate an asynchronous preset register into a functionally equivalent asynchronous preset register using an asynchronous reset register, use the following examples to design an asynchronous reset register.

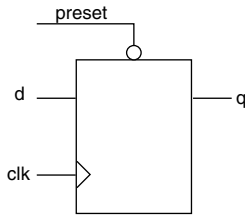

Figure 4-3. Asynchronous Reset

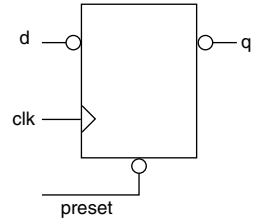

Figure 4-4. Equivalent Asynchronous Reset

Verilog Asynchronous Preset

```
// Active-low async preset flip-flop
module dfp (q, d, clk, preset);
input d, clk, preset;
output q;
reg q;

always @(posedge clk or negedge preset)
    if (!preset)
        q = 1'b1;
    else
        q = d;
endmodule
```

Verilog Equivalent Asynchronous Preset

```
/* Equivalent active-low async preset flip-flop, using an
async reset flop with bubbled d and q */
module dfp_r (q, d, clk, preset);
input d, clk, preset;
output q;
wire d_inv, reset;
reg q_inv;

assign d_inv = !d;
assign q = !q_inv;
assign reset = preset;
always @(posedge clk or negedge reset)
    if (!reset)
        q_inv = 1'b0;
    else
        q_inv = d_inv;
endmodule
```

VHDL Asynchronous Preset

```
-- register with active low async preset.

library ieee;
use ieee.std_logic_1164.all;
entity dfp is
    port (d, clk, preset : in std_logic;
          q : out std_logic;
end dfp;

architecture behav of dfp is
begin
process (clk, preset) begin
    if (preset = '0') then
        q <= '1';
    elsif (clk'event and clk = '1') then
        q <= d;
    end if;
end process;
end behav;
```

VHDL Equivalent Asynchronous Preset

```
-- register with active low async preset.

library ieee;
use ieee.std_logic_1164.all;
entity dfp_r is
    port (d, clk, preset : in std_logic;
          q : out std_logic);
end dfp_r;

architecture behav of dfp_r is
    signal reset, d_tmp, q_tmp : std_logic;
begin
    reset <= preset;
    d_tmp <= NOT d;
    process (clk, reset) begin
        if (reset = '0') then
            q_tmp <= '0';
        elsif (clk'event and clk = '1') then
            q_tmp <= d_tmp;
        end if;
    end process;
    q <= NOT q_tmp;
end behav;
```

Asynchronous Preset and Clear

This is the most problematic register for the ACT 2, XL, DX, MX, SX and ACT 3 architectures. You can only use one cell (the DFPC cell) to design an asynchronous preset and clear register. The DFPC uses two CMODs to form a master latch and a slave latch that together form one register. This uses two CMODs per register and offers no logic combinability with the SMOD. The DFPC requires more setup time and no combinability. The net timing loss can often be as high as 10ns. Actel recommends that you do not use any asynchronous preset and clear registers on critical paths. Use a synchronous preset with asynchronous clear or a synchronous clear register instead.

You can use an asynchronous preset and clear register if it does not affect a critical path or cause high utilization in the design.

Registered I/Os

The ACT 3 technology has registers in the I/O ring, with both reset and preset, which allow for fast input setup and clock-to-out delays. Because most synthesis tools do not infer these special resources, the following example shows how to instantiate a registered I/O cell, BREPTH, in your design.

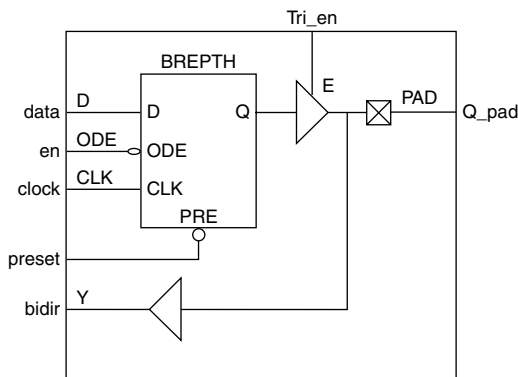

Figure 4-5. Registered I/O Cell

VHDL

```
library IEEE;
use IEEE.std_logic_1164.all;

entity regio is
    port (data, en, Tri_en, clock, preset : in std_logic;
          bidir : inout std_logic;
          q_pad : out std_logic);
end regio;

architecture rtl of regio is

-- Component Declaration
component BREPTH
    port (D, ODE, E, IOPCL, CLK : in std_logic;
          Y : out std_logic;
          PAD : inout std_logic);
end component;

begin
-- Concurrent Statement
U0 : BREPTH port map ( D => data,
                      ODE => en,
                      E => Tri_en,
                      IOPCL => preset,
                      CLK => clock,
                      Y => q_pad,
                      PAD => bidir);

end rtl;
```

Verilog

```
module regio (data, Q_pad, clock, preset, Tri_en, en, bidir);

    input  data, clock, preset, Tri_en, en;
    output Q_pad;
    inout  bidir;

    BREPTH U1 (.PAD(Q_pad), .D(data), .CLK(clock), .IOPCL(preset),
              .E(Tri_en), .ODE(en), .Y(bidir));

endmodule
```

Note: As a good design practice, instantiate all input/output cells at the top level of your design.

CLKINT/CLKBUF for Reset and/or High Fanout Networks

Many designs have internally generated clocks, high fanout control signals, or internally generated reset signals. These signals need a large internal driver, CLKINT, to meet both area and performance goals for the circuit. If the high fanout signals come directly into the design through an I/O, a CLKBUF driver is used. Most synthesis tools do not automatically use these drivers. Instead, the synthesis tool builds a buffer tree that consumes one module per driver. On a high fanout net this can affect both the area and timing for that signal. If the global drivers for a given array are still available, you should instantiate the CLKINT or CLKBUF driver into the design. The following example shows how to instantiate these drivers.

CLKINT

The following examples instantiate the CLKINT driver.

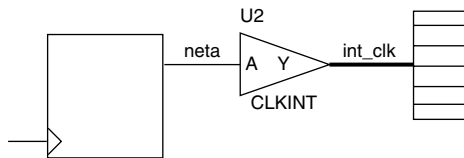

VHDL

```

library IEEE;
use IEEE.std_logic_1164.all;

entity design is
    port (..... : in std_logic;
          ..... : out std_logic);
end design;

    architecture rtl of design is
        signal neta, int_clk : std_logic;
-- Component Declaration
    component CLKINT
        port (A : in std_logic;
              Y : out std_logic);
    end component;

begin
-- Concurrent Statement
U2 : CLKINT port map ( A => neta,
                      Y => int_clk);
end rtl;

```

Verilog

```
module design (.....);  
  
    input .....;  
    output .....;  
    CLKINT U2 (.Y(int_clk), .A(neta));  
    .....  
    .....  
endmodule
```

CLKBUF

The following examples instantiate a CLKBUF driver.

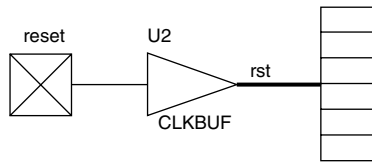

VHDL

```
library IEEE;  
use IEEE.std_logic_1164.all;  
  
entity design is  
port (PAD : in std_logic;  
      Y : out std_logic);  
end component;  
  
begin  
    -- Concurrent Statement  
    U2 : CLKBUF port map (PAD => reset, Y => rst_rst);  
end rtl;
```

Verilog

```
module design (.....);  
  
    input .....;  
    output .....;  
    CLKBUF U2 (.Y(rst), .PAD(reset));  
    .....  
    .....  
endmodule
```

QCLKINT/QCLKBUF for Medium Fanout Networks

The 32100DX, 32200DX, 32300DX, and 42MX36 have four quadrant clocks that can be used to drive internally generated high fanout nets (QCLKINT) or high fanout nets generated from I/O ports (QCLKBUF). The methodology and instantiation are similar to the CLKINT/CLKBUF drivers. However, the QCLK drivers can only drive within a quadrant. Although the placement of the cells into a quadrant is automated by the Designer place-and-route software, you must limit the number of fanouts and prevent the use of multiple QCLK signals to drive the same cell or gate.

You can double your fanout limit and drive half the chip by combining two drivers into one to drive 2 quadrants. However, each time you combine drivers, you reduce the number of available QCLKs by one. The Designer place-and-route software automatically combines QCLKs when necessary

ACTgen Counter

Several synthesis tools cannot build an optimal counter implementation for the Actel architecture. If a counter is on a critical path, this implementation can increase logic level usage and decrease performance. To reduce critical path delays and to achieve optimal results from your design, Actel recommends that you instantiate counters generated by the ACTgen Macro Builder. The ACTgen Macro Builder supports a wide variety of counters for area and performance needs.

The following example uses a 5-bit counter with load, count enable, and asynchronous reset that has been generated with ACTgen and

saved as a structural HDL netlist called “CNT5”. The counter is instantiated as follows:

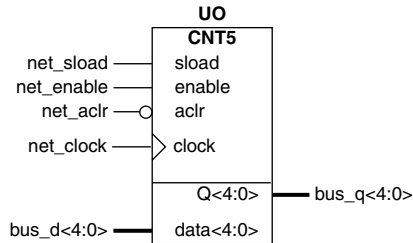

VHDL

```
library IEEE;
use IEEE.std_logic_1164.all;

entity counter is
    port (bus_d : in std_logic_vector(4 downto 0);
          bus_q : out std_logic_vector(4 downto 0);
          net_clock, net_aclr, net_enable : in std_logic;
          net_sload : in std_logic);
end counter;

architecture rtl of counter is

-- Component Declaration
component CNT5
    port (Data : in std_logic_vector(4 downto 0);
          Sload, Enable, Aclr, Clock : in std_logic;
          Q : out std_logic_vector(4 downto 0));
end component;

begin
-- Concurrent Statement
U0 : CNT5 port map (Data => bus_d,
                   Sload => net_sload,
                   Enable => net_enable,
                   Aclr => net_aclr,
                   Clock => net_clock,
                   Q => bus_q);

end rtl;
```

Verilog

```
module counter (bus_q, bus_d, net_clock, net_aclr, net_enable,
```

```
        net_sload);  
    input [4:0] data;  
    input net_sload, net_enable, net_aclr, net_clock;  
    output [4:0] bus_q;  
  
CNT5 U0 (.Q(bus_q), .Data(bus_d), .Clock(net_clock),  
.Aclr(net_aclr), .Enable(net_enable), .Sload(net_sload));  
  
endmodule
```

Dual Architecture Coding in VHDL

It is possible to maintain technology independence after instantiating an ACTgen macro into your design. By adding a second technology independent architecture, you can maintain two functionally equivalent architectures of the same entity in your design. The ACTgen macro is Actel specific and instantiated in your design to take advantage of the architectural features of the target Actel FPGA. This allows you to meet your design goals quickly. The technology independent architecture is functionally equivalent to the Actel specific architecture (verified by simulation) and can be used to synthesize the design to another technology if necessary. The following example shows the technology independent (RTL) and Actel specific (structural) architecture for a counter called “CNT5” and illustrates how to write your code so that you can choose which architecture to use.

RTL Architecture

This implementation of “CNT5” is written as a behavioral description directly into the design.

```
library IEEE;  
use IEEE.std_logic_1164.all;  
use IEEE.std_logic_unsigned.all;  
  
entity CNT5 is  
    port (Data: in std_logic_vector(4 downto 0);  
          Sload, Enable, Aclr, Clock: in std_logic;  
          Q: out std_logic_vector(4 downto 0));  
end CNT5;  
  
architecture RTL of CNT5 is  
  
    signal cnt: std_logic_vector(4 downto 0);
```

```
begin
counter : process (Aclr, Clock)
begin
if (Aclr = '0') then
cnt <= (others => '0');           -- asynchronous reset
elsif (Clock'event and Clock = '1') then
if (Sload = '1') then
cnt <= Data;-- synchronous load
elsif (Enable = '1') then
cnt <= cnt + '1';               -- increment counter
end if;
end if;
end process;
Q <= cnt;                        -- assign counter output to output port
end RTL;
```

Structural Architecture

This implementation of “CNT5” is created by the ACTgen macro builder. The port names for the RTL description must match the port names of the structural “CNT5” netlist generated by ACTgen.

```
library ieee;
use ieee.std_logic_1164.all;
library ACT3;

entity CNT5 is
port (Data : in std_logic_vector(4 downto 0); Enable, Sload,
      Aclr, Clock : in std_logic; Q : out std_logic_vector(4
      downto 0)) ;
end CNT5;

architecture DEF_ARCH of CNT5 is

  component DFM7A
  port(D0, D1, D2, D3, S0, S10, S11, CLR, CLK : in
        std_logic; Q : out std_logic);
  end component;

  . . .

end DEF_ARCH;
```

Instantiating “CNT5” in the Top Level Design

Once you have created both architectures, instantiate “CNT5” into your design, adding binding statements for both architectures. The binding statements are used to specify which architecture the synthesis tool uses in the design. The technology independent RTL architecture might not meet the performance requirements. The Actel specific DEF_ARCH architecture is optimized for the Actel FPGA architecture and may provide higher performance. By removing the comment on one of the “use” statements in the code, a particular architecture can be chosen to meet the design needs.

```

library IEEE;
use IEEE.std_logic_1164.all;

entity counter is
port (bus_d: in std_logic_vector(4 downto 0);
       bus_q: out std_logic_vector(4 downto 0);
       net_clock, net_aclr, net_enable: in std_logic;
       net_sload: in std_logic);
end counter;

architecture RTL of counter is

-- Component Declaration
component CNT5
port (Data : in std_logic_vector(4 downto 0); Enable, Sload,
      Aclr, Clock : in std_logic; Q : out std_logic_vector(4
      downto 0));
end component;

-- Binding statements to specify which CNT5 architecture to use
-- RTL architecture for behavioral CNT5
-- DEF_ARCH architecture for structural (ACTgen) CNT5
-- for all: CNT5 use entity work.CNT5 (RTL);
-- for all: CNT5 use entity work.CNT5 (DEF_ARCH);

begin
-- Concurrent Statement
U0: CNT5 port map (Data => bus_d,
                  Sload => net_sload,
                  Enable => net_enable,
                  Aclr => net_aclr;
                  Clock => net_clock,
                  Q => bus_q);

end rtl;

```

SRAM

The following examples show how to create register-based SRAM for non-SRAM based Actel devices.

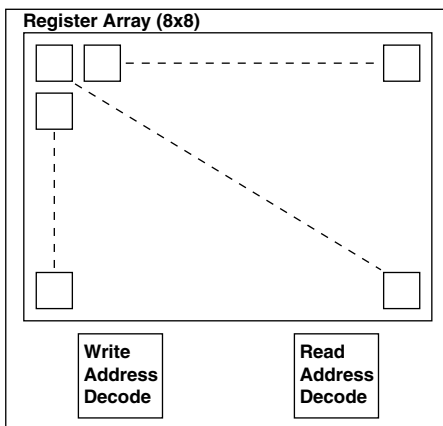

Figure 4-6. RAM Behavioral Simulation Model

Register-Based Single Port SRAM

The following example shows the behavioral model for a 8x8 RAM cell. To modify the width or depth, simply modify the listed parameters in the code. The code assumes that you want to use “posedge clk” and “negedge reset.” Modify the “always” blocks if that is not the case.

VHDL

```
-- *****  
-- Behavioral description of a single-port SRAM with:  
--   Active High write enable (WE)  
--   Rising clock edge (Clock)  
-- *****  
  
library ieee;  
use ieee.std_logic_1164.all;  
use IEEE.std_logic_arith.all;  
use IEEE.std_logic_unsigned.all;  
  
entity reg_sram is  
  generic (width : integer:=8;  
          depth  : integer:=8;  
          addr   : integer:=3);
```

```

    port (Data    : in std_logic_vector (width-1 downto 0);
          Q       : out std_logic_vector (width-1 downto 0);
          Clock   : in std_logic;
          WE      : in std_logic;
          Address : in std_logic_vector (addr-1 downto 0));
end reg_sram;

architecture behave of reg_sram is
    type MEM is array (0 to depth-1) of std_logic_vector(width-1
    downto 0);
    signal ramTmp : MEM;
begin
    process (Clock)
    begin
        if (clock'event and clock='1') then
            if (WE = '1') then
                ramTmp (conv_integer (Address)) <= Data;
            end if;
        end if;
    end process;
    Q <= ramTmp(conv_integer(Address));
end behave;

```

Verilog

```

`timescale 1 ns/100 ps
#####
// Behavioral single-port SRAM description :
// Active High write enable (WE)
// Rising clock edge (Clock)
#####

module reg_sram (Data, Q, Clock, WE, Address);

    parameter width = 8;
    parameter depth = 8;
    parameter addr = 3;

    input Clock, WE;
    input [addr-1:0] Address;
    input [width-1:0] Data;
    output [width-1:0] Q;
    wire [width-1:0] Q;
    reg [width-1:0] mem_data [depth-1:0];

    always @(posedge Clock)
        if (WE)
            mem_data[Address] = #1 Data;

    assign Q = mem_data[Address];

endmodule

```

Register-Based Dual-Port SRAM

The following example shows the behavioral model for a 8x8 RAM cell. This code was designed to imitate the behavior of the Actel DX family dual-port SRAM and to be synthesizable to a register based SRAM module. To modify the width or depth, modify the listed parameters in the code. The code assumes that you want to use “posedge clk” and “negedge reset.” Modify the “always” blocks if that is not the case.

VHDL

```
-- Behavioral description of dual-port SRAM with :
--   Active High write enable (WE)
--   Active High read enable (RE)
--   Rising clock edge (Clock)

library ieee;
use ieee.std_logic_1164.all;
use IEEE.std_logic_arith.all;
use IEEE.std_logic_unsigned.all;

entity reg_dpram is
  generic (width      : integer:=8;
          depth       : integer:=8;
          addr        : integer:=3);
  port (Data      : in std_logic_vector (width-1 downto 0);
        Q         : out std_logic_vector (width-1 downto 0);
        Clock     : in std_logic;
        WE        : in std_logic;
        RE        : in std_logic;
        WAddress: in std_logic_vector (addr-1 downto 0);
        RAddress: in std_logic_vector (addr-1 downto 0));
end reg_dpram;

architecture behav of reg_dpram is
  type MEM is array (0 to depth-1) of std_logic_vector(width-1
  downto 0);
  signal ramTmp : MEM;
begin

  -- Write Functional Section

  process (Clock)
  begin
    if (clock'event and clock='1') then
      if (WE = '1') then
        ramTmp (conv_integer (WAddress)) <= Data;
      end if;
    end if;
  end process;

  -- Read Functional Section
```

```

process (Clock)
begin
    if (clock'event and clock='1') then
        if (RE = '1') then
            Q <= ramTmp(conv_integer (RAddress));
        end if;
    end if;
end process;

end behav;

```

Verilog

```

`timescale 1 ns/100 ps
//#####
// Behavioral dual-port SRAM description :
//# Active High write enable (WE)
//# Active High read enable (RE)
//# Rising clock edge (Clock)
//#####

module reg_dpram (Data, Q, Clock, WE, RE, WAddress, RAddress);

parameter width = 8;
parameter depth = 8;
parameter addr = 3;

input Clock, WE, RE;
input [addr-1:0] WAddress, RAddress;
input [width-1:0] Data;
output [width-1:0] Q;
reg [width-1:0] Q;
reg [width-1:0] mem_data [depth-1:0];

// #####
// # Write Functional Section
// #####
always @(posedge Clock)
begin
    if (WE)
        mem_data[WAddress] = #1 Data;
end

//#####
//# Read Functional Section
//#####
always @(posedge Clock)
begin
    if (RE)
        Q = #1 mem_data[RAddress];
end
end

```

```
endmodule
```

ACTgen RAM

The RAM cells in the 3200DX and 42 MX families of devices support asynchronous and synchronous dual-port RAM. The basic RAM cells can be configured as 32x8 or 64x4. However, most synthesis tools cannot infer technology specific features (such as RAM cells). The following example shows an ACTgen structural implementation for instantiation. Although the behavioral description is synthesizable, the implementation is not optimal for speed and area.

Using ACTgen, generate a 32x16 dual port RAM with the configuration shown in the figure below. Save the structured Verilog or VHDL implementations as “ram.”

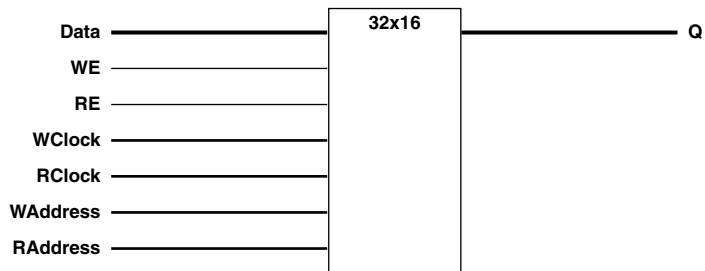

VHDL

```
library IEEE;
use IEEE.std_logic_1164.all;
use IEEE.std_logic_unsigned.all;

entity ram32_16 is
    port (WAddress, RAddress:in std_logic_vector(4 downto 0);
          Data : in std_logic_vector (15 downto 0);
          Aclr, WClock, RClock,WE,RE:in std_logic;
          Q :out std_logic_vector (15 downto 0));
end ram32_16;

architecture rtl of ram32_16 is

component ram
    port (Data      : in std_logic_vector (15 downto 0);
          Aclr      : in std_logic;
          WE        : in std_logic ;
          RE        : in std_logic ;
```

```

        WClock  : in std_logic ;
        RClock  : in std_logic ;
        WAddress: in std_logic_vector (4 downto 0);
        RAddress: in std_logic_vector (4 downto 0);
        Q       : out std_logic_vector (15 downto 0));
end component;

begin

R_32_16: ram
    port map (Data => Data,
              Aclr => Aclr,
              WE => WE,
              WAddress => WAddress,
              RE => RE,
              RAddress => RAddress,
              WClock => WClock,
              RClock => RClock,
              Q => Q);

end rtl;

```

Verilog

```

module ram (WAddress, RAddress, Data, WClock, WE,
           RE, Rclock, Q);
    input  [4:0] WAddress, RAddress;
    input  [15:0] Data;
    input  Rclock, WClock;
    input  WE, RE;
    output [15:0] Q;

    ram R_32_16 (.Data(Data), .WE(WE), .RE(RE), .WClock(WClock),
                .Rclock(Rclock), .Q(Q), .WAddress(WAddress),
                .RAddress(RAddress));

endmodule

```

FIFO

The following example shows how to create a register-based FIFO for non-SRAM based Actel devices.

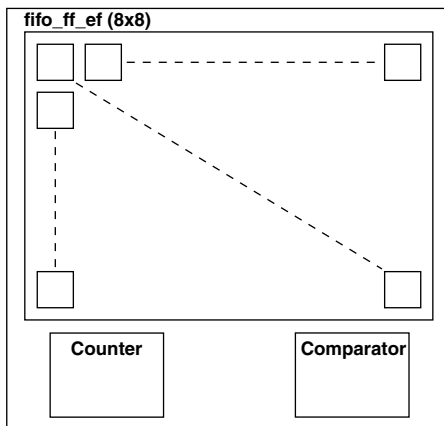

Figure 4-7. FIFO Behavioral Simulation Mode

Register-Based FIFO

The following example show the behavioral model for an 8x 8 FIFO. This code was designed to imitate the behavior of the Actel DX family dual-port SRAM based FIFO and to be synthesizable to a register-based FIFO. To modify the width or depth, simply modify the listed parameters in the code. However, the code does assume that you want to use posedge clk and negedge reset. Modify the always blocks if that is not the case.

VHDL

```
-- *****
-- Behavioral description of dual-port FIFO with :
--   Active High write enable (WE)
--   Active High read enable (RE)
--   Active Low asynchronous clear (Aclr)
--   Rising clock edge (Clock)
--   Active High Full Flag
--   Active Low Empty Flag
-- *****
```



```

library ieee;
use ieee.std_logic_1164.all;
use IEEE.std_logic_arith.all;

entity reg_fifo is

generic (width    : integer:=8;
          depth    : integer:=8;
          addr     : integer:=3);

port (Data      : in std_logic_vector (width-1 downto 0);
       Q         : out std_logic_vector (width-1 downto 0);
       Aclr      : in std_logic;
       Clock     : in std_logic;
       WE        : in std_logic;
       RE        : in std_logic;
       FF        : out std_logic;
       EF        : out std_logic);

end reg_fifo;

library ieee;
use ieee.std_logic_1164.all;
use IEEE.std_logic_arith.all;
use IEEE.std_logic_unsigned.all;

architecture behavioral of reg_fifo is

    type MEM is array(0 to depth-1) of std_logic_vector(width-1 downto
0);
    signal ramTmp      : MEM;
    signal WAddress    : std_logic_vector (addr-1 downto 0);
    signal RAddress    : std_logic_vector (addr-1 downto 0);
    signal words       : std_logic_vector (addr-1 downto 0);

begin

    -- #####
    -- # Write Functional Section
    -- #####

    WRITE_POINTER : process (Aclr, Clock)
    begin
        if (Aclr = '0') then
            WAddress <= (others => '0');
        elsif (Clock'event and Clock = '1') then
            if (WE = '1') then
                if (WAddress = words) then

```

```
        WAddress <= (others => '0');
    else
        WAddress <= WAddress + '1';

    end if;
end if;
end process;

WRITE_RAM : process (Clock)
begin
if (Clock'event and Clock = '1') then
    if (WE = '1') then
        ramTmp (conv_integer (WAddress)) <= Data;
    end if;
end if;
end process;

-- #####
-- # Read Functional Section
-- #####

READ_POINTER : process (Aclr, Clock)
begin
    if (Aclr = '0') then
        RAddress <= (others => '0');
    elsif (Clock'event and Clock = '1') then
        if (RE = '1') then
            if (RAddress = words) then
                RAddress <= (others => '0');
            else
                RAddress <= RAddress + '1';
            end if;
        end if;
    end if;
end process;

READ_RAM : process (Clock)
begin
    if (Clock'event and Clock = '1') then
        if (RE = '1') then
            Q <= ramTmp(conv_integer(RAddress));
        end if;
    end if;
end process;
```

```

-- #####
-- # Full Flag Functional Section : Active high
-- #####

FFLAG : process (Aclr, Clock)
begin
  if (Aclr = '0') then
    FF <= '0';
  elsif (Clock'event and Clock = '1') then
    if (WE = '1' and RE = '0') then
      if ((WAddress = RAddress-1) or
          ((WAddress = depth-1) and (RAddress = 0))) then
        FF <= '1';
      end if;
    else
      FF <= '0';
    end if;
  end if;
end process;

-- #####
-- # Empty Flag Functional Section : Active low
-- #####

EFLAG : process (Aclr, Clock)
begin
  if (Aclr = '0') then
    EF <= '0';
  elsif (Clock'event and Clock = '1') then
    if (RE = '1' and WE = '0') then
      if ((WAddress = RAddress+1) or
          ((RAddress = depth-1) and (WAddress = 0))) then
        EF <= '0';
      end if;
    else
      EF <= '1';
    end if;
  end if;
end process;

end behavioral;

```

Verilog

```
`timescale 1 ns/100 ps
#####
// Behavioral description of FIFO with :
// Active High write enable (WE)
// Active High read enable (RE)
// Active Low asynchronous clear (Aclr)
// Rising clock edge (Clock)
// Active High Full Flag
// Active Low Empty Flag
#####

module reg_fifo (Data, Q, Aclr, Clock, WE, RE, FF, EF);

parameter width = 8;
parameter depth = 8;
parameter addr = 3;

input Clock, WE, RE, Aclr;
input [width-1:0] Data;
output FF, EF; // Full & Empty Flags
output [width-1:0] Q;
reg [width-1:0] Q;
reg [width-1:0] mem_data [depth-1:0];
reg [addr-1:0] WAddress, RAddress;
reg FF, EF;

// #####
// # Write Functional Section
// #####
// WRITE_ADDR_POINTER
always @ (posedge Clock or negedge Aclr)
begin
    if (!Aclr)
        WAddress = #2 0;
    else if (WE)
        WAddress = #2 WAddress + 1;
end

// WRITE_REG
always @ (posedge Clock)
begin
    if (WE)
        mem_data[WAddress] = Data;
end

end
```

```

#####
//# Read Functional Section
#####
// READ_ADDR_POINTER
always @ (posedge Clock or negedge Aclr)
begin
    if(!Aclr)
        RAddress = #1 0;
    else if (RE)
        RAddress = #1 RAddress + 1;
end

// READ_REG
always @ (posedge Clock)
begin
    if (RE)
        Q = mem_data[RAddress];
end

#####
//# Full Flag Functional Section : Active high
#####
always @ (posedge Clock or negedge Aclr)
begin
    if(!Aclr)
        FF = #1 1'b0;
    else if ((WE & !RE) && ((WAddress == RAddress-1) ||
        ((WAddress == depth-1) && (RAddress == 1'b0))))
        FF = #1 1'b1;
    else
        FF = #1 1'b0;
end

#####
//# Empty Flag Functional Section : Active low
#####
always @ (posedge Clock or negedge Aclr)
begin
    if(!Aclr)
        EF = #1 1'b0;
    else if ((!WE & RE) && ((WAddress == RAddress+1) ||
        ((RAddress == depth-1) && (WAddress == 1'b0))))
        EF = #1 1'b0;
    else
        EF = #1 1'b1;
end

endmodule

```

ACTgen FIFO

The RAM cells in the 3200DX and 42MX families of devices can be used to implement a variety of FIFOs. The behavioral description of a 32x8 FIFO for simulation is shown below. However, most synthesis tools cannot infer technology specific features such as RAM cells. Synthesizing this model will result in high area utilization. ACTgen can generate an area and performance optimized structured HDL netlist for instantiation.

Using ACTgen, generate a 32x8 FIFO with the configuration shown in the figure below. Save it as a Verilog or VHDL netlist called “fifo_ff_ef.”

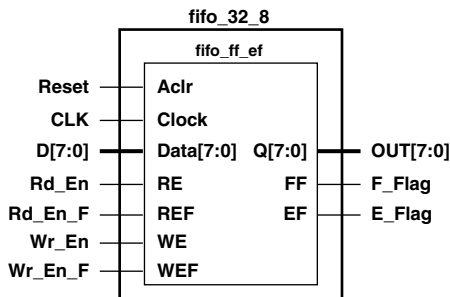

VHDL

```

library IEEE;
use IEEE.std_logic_1164.all;

entity fifo_32_8 is
port (D
      : in std_logic_vector(7 downto 0);
      OUT
      : out std_logic_vector(7 downto 0);
      Reset
      : in std_logic;
      Rd_En, Wr_En
      : in std_logic;
      Rd_En_F, Wr_En_F
      : in std_logic;
      clk
      : in std_logic;
      E_Flag, F_Flag
      : out std_logic);
end fifo_32_8;

architecture fifo_arch of fifo_32_8 is
  component fifo_ff_ef
    generic (width : integer;
            depth  : integer;
            clrPola : integer;
            clkEdge : integer);
    port (Data : in std_logic_vector (width-1 downto 0);
          Aclr : in std_logic);
  end component;

```

```

        WE      : in std_logic ;
        WEF     : in std_logic ;
        RE      : in std_logic ;
        REF     : in std_logic ;
        Clock   : in std_logic ;
        Q       : out std_logic_vector (width-1 downto 0);
        FF      : out std_logic;
        EF      : out std_logic);

    end component;

begin

F_32_8: fifo_ff_ef
    generic map (width => 8, depth => 32, clrPola => 1,
                clkEdge => 1)
    port map (Data => D,
              Aclr => Reset,
              WE => We_En,
              WEF => We_En_F,
              RE => Rd_En,
              REF => Rd_En_F,
              Clock => CLK,
              Q => OUT,
              FF => F_Flag,
              EF => E_Flag);

end fifo_arch;

```

Verilog

```

module fifo_32_8 (D, OUT, Reset, Rd_En, Wr_En, CLK, E_Flag,
                 Rd_En_F, Wr_En_F, F_Flag);
    input      [7:0] D;
    output     [7:0] OUT;
    input      Reset;
    input      Rd_En;
    input      Rd_En_F;
    input      Wr_En;
    input      Wr_En_F;
    input      CLK;
    output     E_Flag;
    output     F_Flag;
    wire      [7:0] OUT;
    wire      E_Flag;
    wire      F_Flag;

    fifo_ff_ef F_32_8 (.Data(D), .Aclr(Reset), .WE(Wr_En),
                     .WEF(Wr_En_F), .RE(Rd_En), .REF(Rd_En_F)
                     .Clock(CLK), .Q(OUT), .FF(F_Flag), .EF(E_Flag));

endmodule

```

Product Support

Actel backs its products with various support services including Customer Service, a Customer Applications Center, a web site, an FTP site, electronic mail, and worldwide sales offices. This appendix contains information about contacting Actel and using these support services.

Actel U.S. Toll-Free Line

Use the Actel toll-free line to contact Actel for sales information, technical support, requests for literature about Actel and Actel products, Customer Service, investor information, and using the Action Facts service.

The Actel toll-free line is (888) 99-ACTEL.

Customer Service

Contact Customer Service for nontechnical product support, such as product pricing, product upgrades, update information, order status, and authorization.

From Northeast and North Central U.S.A., call (408) 522-4480.

From Southeast and Southwest U.S.A., call (408) 522-4480.

From South Central U.S.A., call (408) 522-4434.

From Northwest U.S.A., call (408) 522-4434.

From Canada, call (408) 522-4480.

From Europe, call (408) 522-4252 or +44 (0) 1256 305600.

From Japan, call (408) 522-4743.

From the rest of the world, call (408) 522-4743.

Fax, from anywhere in the world (408) 522-8044.

Customer Applications Center

Actel staffs its Customer Applications Center with highly skilled engineers who can help answer your hardware, software, and design questions. The Applications Center spends a great deal of time creating application notes and answers to FAQs. So, before you contact us, please visit our online resources. It is very likely we have already answered your question(s).

Guru Automated Technical Support

Guru is a web-based automated technical support system accessible through the Actel home page (<http://www.actel.com/guru/>). Guru provides answers to technical questions about Actel products. Many answers include diagrams, illustrations, and links to other resources on the Actel web site. Guru is available 24 hours a day, seven days a week.

Web Site

Actel has a World Wide Web home page where you can browse a variety of technical and nontechnical information. Use a Net browser (Netscape recommended) to access Actel's home page.

The URL is <http://www.actel.com>. You are welcome to share the resources provided on the Internet.

Be sure to visit the Technical Documentation area on our web site, which contains information regarding products, technical services, current manuals, and release notes.

You can visit the Product Support area of the Actel website from your Designer software. Click the Product Support button in your Designer Main Window to access the latest datasheets, application notes, and more.

FTP Site

Actel has an anonymous FTP site located at **ftp://ftp.actel.com**. Here you can obtain library updates, software patches, design files, and data sheets.

Contacting the Customer Applications Center

Highly skilled engineers staff the Customer Applications Center from 7:30 A.M. to 5:00 P.M., Pacific Time, Monday through Friday. Several ways of contacting the Center follow:

Electronic Mail

You can communicate your technical questions to our e-mail address and receive answers back by e-mail, fax, or phone. Also, if you have design problems, you can e-mail your design files to receive assistance. We constantly monitor the e-mail account throughout the day. When sending your request to us, please be sure to include your full name, company name, and your contact information for efficient processing of your request.

The technical support e-mail address is **tech@actel.com**.

Telephone

Our Technical Message Center answers all calls. The center retrieves information, such as your name, company name, phone number and your question, and then issues a case number. The Center then forwards the information to a queue where the first available application engineer receives the data and returns your call. The phone hours are from 7:30 A.M. to 5:00 A.M., Pacific Time, Monday through Friday.

The Customer Applications Center number is (800) 262-1060.

European customers can call +44 (0) 1256 305600.

Worldwide Sales Offices

Headquarters

Actel Corporation
955 East Arques Avenue
Sunnyvale, California 94086
Toll Free: 888.99.ACTEL

Tel: 408.739.1010
Fax: 408.739.1540

US Sales Offices

California

Bay Area
Tel: 408.328.2200
Fax: 408.328.2358

Irvine
Tel: 949.727.0470
Fax: 949.727.0476

Newbury Park
Tel: 805.375.5769
Fax: 805.375.5749

Colorado

Tel: 303.420.4335
Fax: 303.420.4336

Florida

Tel: 407.977.6846
Fax: 407.977.6847

Georgia

Tel: 770.277.4980
Fax: 770.277.5896

Illinois

Tel: 847.259.1501
Fax: 847.259.1575

Massachusetts

Tel: 978.244.3800
Fax: 978.244.3820

Minnesota

Tel: 651.917.9116
Fax: 651.917.9114

New Jersey

Tel: 609.517.0304

North Carolina

Tel: 919.654.4529
Fax: 919.674.0055

Pennsylvania

Tel: 215.830.1458
Fax: 215.706.0680

Texas

Tel: 972.235.8944
Fax: 972.235.965

International Sales Offices

Canada

235 Stafford Rd. West,
Suite 106
Nepean, Ontario K2H 9C1

Tel: 613.726.7575
Fax: 613.726.8666

France

Actel Europe S.A.R.L.
361 Avenue General de Gaulle
92147 Clamart Cedex

Tel: +33 (0)1.40.83.11.00
Fax: +33 (0)1.40.94.11.04

Germany

Lohweg 27
85375 Neufahrn
Tel: +49 (0)8165.9584.0
Fax: +49 (0)8165.9584.1

Italy

Via de Garibaldini, No. 5
20019 Settimo Milanese,
Milano, Italy

Japan

EXOS Ebisu Building 4F
1-24-14 Ebisu Shibuya-ku
Tokyo 150

Tel: +81 (0)3.3445.7671
Fax: +81 (0)3.3445.7668

Korea

30th Floor, ASEM Tower,
159-1 Samsung-dong,
Kangam-ku,
Seoul, Korea

Tel: +82.2.6001.3382
Fax: +82.2.6001.3030

United Kingdom

Maxfli Court,
Riverside Way
Camberley,
Surrey GU15 3YL

Tel: +44 (0)1276.401452
Fax: +44 (0)1276.401490

INDEX

A

ACT 3 I/O 75
Actel
 FTP Site 101
 Web Based Technical Support 100
 Web Site 100
Actel Manuals xiii
ACTgen
 Counter Instantiation 79
 FIFO 96
 RAM 88
Addition 31
Arithmetic Operator 31
 Shift Register Implementation 32
Assumptions x

B

Behavioral Simulation 2
BREPTH 75

C

Capturing a Design 2
Case Statement 21, 65
 Adding Directive 65
CLKBUF 77
CLKINT 77
Coding Dual Architecture 81
 Instantiating 83
 RTL 81
 Structural 82
Combinatorial/Sequential Module Merging 59
Combining Logic 56, 59
Component
 Size 51
 Width 51
Contacting Actel

 Customer Service 99
 Electronic Mail 101
 Technical Support 100
 Toll-Free 99
 Web Based Technical Support 100
Conventions x
 Document x
 Naming, Verilog xii
 Naming, VHDL xi
Counter 27–31
 8-Bit, Count Enable, Asynchronous Reset 28
 8-Bit, Load and Asynchronous Reset 29
 8-Bit, Load, Count Enable, Terminal Count and
 Asynchronous Reset 30
 Instantiation 79
 N-Bit, Load, Count Enable, and Asynchronous
 Reset 30
 Recommendations 27, 79
Critical Path Logic Reduction 53
Customer Service 99

D

Data Shift 35
Datapath 19–36
 Arithmetic Operator 31
 Counter 27
 Decoder 26
 Equality Operator 34
 If-Then-Else 19
 Multiplexor 21
 Relational Operator 33
 Shift Operator 35
Decoder 26
Design Creation/Verification 2
 Behavioral Simulation 2
 EDIF Netlist Generation 3

- HDL Source Entry 2
- Structural Netlist Generation 3
- Structural Simulation 3
- Synthesis 2
- Design Flow
 - Design Creation/Verification 2
 - Design Implementation 3
 - Programming 4
 - System Verification 4
- Design Implementation 3
 - Place and Route 3
 - Timing Analysis 3
 - Timing Simulation 3
- Design Layout 3
- Design Partitioning 63
- Design Synthesis 2
- Designer
 - DT Analyze Tool 3
 - Place and Route 3
 - Timing Analysis 3
- Device Programming 4
- DFPC Cell 75
- Division 31
- D-Latch 5–17
 - with Asynchronous Reset 16
 - with Data and Enable 13
 - with Gated Asynchronous Data 14
 - with Gated Enable 15
- Document
 - Assumptions x
 - Conventions x
 - Organization ix
- Document Conventions x
- Don't Care 25
- DT Analyze 3
- Dual Architecture Coding 81

- Instantiating 83
 - RTL 81
 - Structural 82
- Dual Port SRAM 86, 88
- Duplicating Logic 61

E

- Edge-Triggered Memory Device 5
- EDIF Netlist Generation 3
- Electronic Mail 101
- Equality Operator 34

F

- Fanout
 - High Fanout Networks 77, 79
 - Reducing 61
- FIFO 90–97
 - ACTgen Implementation 96
 - Behavioral Implementation 90
 - Register-Based 90
 - Structural Implementation 96
- Finite State Machine 36–46
 - Combinational Next State Logic 37
 - Combinational Output Logic 37
 - Mealy 39
 - Moore 43
 - One Hot 38
 - Sequential Current State Register 37
 - Structure 37
- Flip-Flop 5–13
 - See Also* Register
 - Positive Edge Triggered 5
 - with Asynchronous Preset 8
 - with Asynchronous Reset 7
 - with Asynchronous Reset and Clock Enable 12
 - with Asynchronous Reset and Preset 9

with Synchronous Preset 11
 with Synchronous Reset 10
 FSM. *See* Finite State Machine

G

Gate-Level Netlist 2
 Generating
 EDIF Netlist 3
 Gate-Level Netlist 2
 Structural Netlist 3
 Generics 51–52
 Greater Than 33
 Greater Than Equal To 33

H

HDL Design Flow
 Design Creation/Verification 2
 Design Implementation 3
 Programming 4
 System Verification 4
 HDL Source Entry 2

I

If-Then-Else Statement 19
 Input-Output Buffer 46–51
 Bi-Directional 49
 Tri-State 47
 Instantiating
 CLKBUF Driver 77
 CLKINT Driver 77
 Counters 79
 Dual Coding 81
 FIFO 96
 QCLKBUF Driver 79
 QCLKINT Driver 79
 RAM 88

Registered I/Os 75
 Internal Tri-State Mapping 65
 Internally Generated Clock 77, 79

K

Keywords
 Verilog xii
 VHDL xi

L

Latch 5
 Master 75
 Slave 75
 Less Than 33
 Less Than Equal To 33
 Level-Sensitive Memory Device 5
 Load Reduction 61
 Logic Level Reduction 53
 Loops 58

M

Merging Logic Modules 59
 Module Block Partitioning 63
 Multiplexor 21, 65
 Case X 25
 Four to One 22
 Mapping Internal Tri-State to 65
 Moving Operators Outside Loops 58
 Twelve to One 23
 Multiplication 31

N

Naming Conventions
 Verilog xii
 VHDL xi
 Netlist Generation

- EDIF 3
 - Gate-Level 2
 - Structural 3

O

- One Hot State Machine 38
- Online Help xvi
- Operators 17
 - Arithmetic 31
 - Equality 34
 - Inside Loops 58
 - Relational 33
 - Removing from Loops 58
 - Shift 35
 - Table of 17

P

- Parallel
 - Encoding 21
 - Operation 65
- Parameters 51–52
- Partitioning a Design 63
- Performance Driven Coding 53–64
- Place and Route 3
- Priority Encoding 19
- Product Support 99–102
 - Customer Applications Center 100
 - Customer Service 99
 - Electronic Mail 101
 - FTP Site 101
 - Technical Support 100
 - Toll-Free Line 99
 - Web Site 100
- Programming a Device 4

Q

- QCLKBUF 79
- QCLKINT 79
- Quadrant Clock 79
 - Limitations 79

R

- RAM 88
- Reducing Fanout 61
- Reducing Logic
 - on a Critical Path 53
 - Usage 56
- Register 68
 - See Also* Flip-Flop
 - Asynchronous Preset 72
 - Asynchronous Preset and Clear 75
 - Clock Enabled 70
 - Duplication 61
 - Functionally Equivalent Asynchronous Preset 72
 - Placed at Hierarchical Boundaries 63
 - Recommended Usage 68–75
 - Synchronous Clear or Preset 69
- Register-Based
 - FIFO 90
 - SRAM 84–88
 - Dual Port 86
 - Single Port 84
- Registered I/O 75
 - BREPTH 75
- Related Manuals xvi
- Relational Operator 33
- Removing Operators from Loops 58
- Reset Signals 77, 79
- Resource Sharing 56

S

- Sequential Device 5–13
 - D-Latch 5
 - Flip-Flop 5
- Sharing Resources 56
- Shift
 - Operator 35
 - Register 32
- Simulation
 - Behavioral 2
 - Structural 3
 - Timing 3
- Single Port SRAM 84
- Size 51
- SRAM 84–89
 - ACTgen Implementation 88
 - Dual Port 86
 - Register Based 84
 - Single Port 84
 - Structural Implementation 88
- Static Timing Analysis 3
- Structural Netlist Generation 3
- Structural Simulation 3
- Subtraction 31
- Synthesis 2
 - Reducing Duration of 63
- System Verification, Silicon Explorer 4

T

- Technical Support 100
- Technology Independent Coding 5–52
- Technology Specific Coding 65–97
- Timing
 - Analysis 3
 - Constraints 53
 - Simulation 3

- Toll-Free Line 99
- Tri-State Mapping 65
- True/False Operands 34

U

- Unit Delays 2

V

- Verilog
 - Naming Conventions xii
 - Reserved Words xii
- VHDL
 - Naming Conventions xi
 - Reserved Words xi

W

- Web Based Technical Support 100
- Width 51

